

The CLT Handbook

CLT structures – design and detailing



Confederation
of Timber
Industries



SWEDISH
WOOD

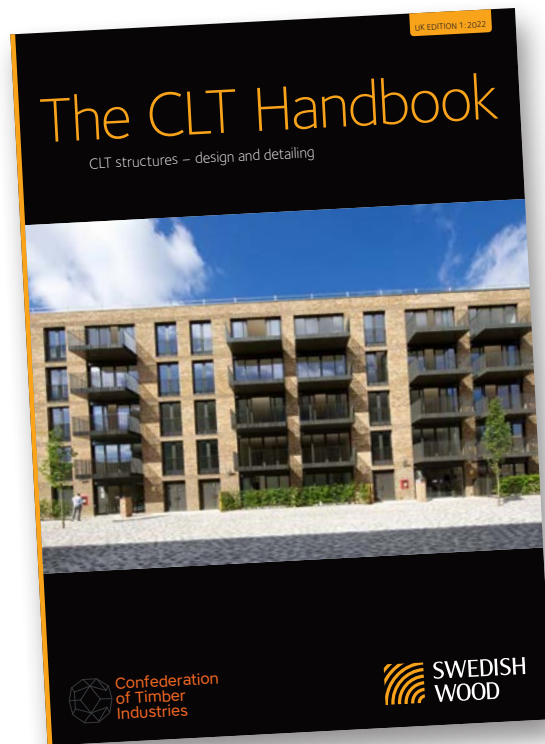

Welcome to the UK edition of the Swedish Wood CLT Handbook, which has been updated and revised for the UK market in collaboration with Arup, Swedish suppliers of cross-laminated timber, and the industry body Swedish Wood.

The CLT Handbook is part of Swedish Wood's investment in handbooks for building in wood. Other handbooks that have been published are:

- Design of timber structures Volume 1, which deals with structural aspects of timber construction.
- Design of timber structures Volume 2, which contains rules and formulas according to Eurocode 5.
- Design of timber structures Volume 3, which includes examples of timber buildings.

Further information about building with wood, including RIBA-accredited online learning modules, can be found at www.woodcampus.co.uk. Further technical information and guidance on wood, CLT and timber construction is available on TräGuiden, www.traguiden.se, which is constantly updated with new knowledge and practical advice. TräGuiden is an extensive resource with tables, drawings and illustrations and available in English using Google Translate.

Information on wood, glulam, CLT and timber construction can also be found at www.swedishwood.com.

Stockholm, August 2022

Johan Fröbel
Swedish Wood

Foreword

The aim of the CLT Handbook is to help structural engineers and architects to design structures using cross-laminated timber (CLT). The handbook describes CLT as a construction material, as well as methods of design.

Since the Swedish Wood CLT Handbook was first published in 2017, there has been a rapid increase in interest in CLT worldwide, thanks to its exceptional sustainability, light weight and suitability for accurate off-site manufacture. At the same time, CLT buildings have been getting taller. This has placed ever-greater responsibility on designers and engineers to ensure they understand how to design safe and strong buildings in CLT, on manufacturers to ensure their products have been tested exhaustively, and on governments to ensure their building codes reflect and demand the latest best practice. It is with this in mind that we have produced this new edition of the handbook.

I am grateful to my colleagues at Arup, Andrew Lawrence and Ishan Abeysekera, for having made a number of changes to the original handbook, not just to reflect the particular circumstances of the UK, but also to include updated information where necessary.

Currently, as a result of the tragic fire at Grenfell Tower (not a timber building), UK building regulations prohibit using flammable materials, such as wood, in the external structure of residential buildings of over 18 metres in height. The timber industry is in the process of undertaking extensive testing to provide further evidence of the fire safety of CLT systems in larger buildings (see [timberfiresafety.org/latest-research](https://www.timberfiresafety.org/latest-research)). This publication incorporates the latest findings and will be updated regularly.

The CLT Handbook refers mainly to European construction standards and the Eurocodes, which are Europe-wide structural design rules for load-bearing capacity, stability and durability. National adaptations have been made to the Eurocodes, based on the member states' particular conditions with regard to geology, climate and culture. The national adaptations for the UK are set out in the UK National Annex to Eurocode 5. Where the current Eurocode lacks suitable rules, other methods have been suggested based on research and best practice and on the draft updates to the Eurocode. The authors have been responsible for interpreting building regulations, research papers, industrial documents and so on, with a view to conveying current design practices.

The handbook needs to be read in conjunction with Approved Documents (for England and Wales), Building standards technical handbooks (for Scotland) and Technical Booklets (for Northern Ireland).

Sections in the CLT handbook covering design and material properties of CLT structures and connections (chapters 2, 3 and 4), fire safety and acoustic performance (chapters 5, 6, 7 and 8) and thermal comfort (chapter 9) need to be viewed in conjunction with the provisions, with a focus on England, of:

- Approved Document A for structures and connections
- Approved Document B (Volumes 1 and 2) for fire safety
- Approved Document C for moisture resistance
- Approved Document E for resistance to sound
- Approved Document L for conservation of fuel and power, specifically thermal performance

This list is not comprehensive, but highlights key reference documents that should always be consulted in their latest version.

The material presented is only intended to provide guidance; the final design responsibility lies with the structural engineer.

Skellefteå, August 2022

Anders Gustafsson
RISE Research Institutes of Sweden AB



Installing CLT

Contents

CLT as a construction material 8

- 1.1 Introduction 8
- 1.2 Architect's view of CLT 9
- 1.3 CLT as a construction material 11
- 1.4 CLT in the eco-cycle 12
- 1.5 CLT manufacture 16
- 1.6 Properties 19
- 1.7 Where can you use CLT? 21

Basis of design of CLT structures 24

- 2.1 Basis of design 24
- 2.2 Material properties of CLT 31

Design of CLT structures 34

- 3.1 Out-of-plane behaviour 34
- 3.2 In-plane behaviour 38
- 3.3 Examples 46
- 3.4 Design and analysis of CLT using software 49
- 3.5 Design tables 50

Connections 52

- 4.1 Design principles 53
- 4.2 Overview of joint types 54
- 4.3 Joint details 55
- 4.4 Design of connections 60

Floors 69

- 5.1 Floors – overview 69
- 5.2 Deformations 72
- 5.3 Dynamics 74
- 5.4 Fire safety 81
- 5.5 Acoustic performance 82
- 5.6 Details 82
- 5.7 Example 84

Walls 86

- 6.1 Overview 86
- 6.2 Structural design 88
- 6.3 CLT shear walls 88
- 6.4 Fire safety 93
- 6.5 Acoustic performance 93
- 6.6 Wall build-ups 93
- 6.7 Connection details 93
- 6.8 Example calculations 96

CLT and fire safety 98

- 7.1 Wood and fire safety 98
- 7.2 Fire resistance of CLT 102
- 7.3 Design and details 107
- 7.4 Examples 108

CLT and sound 112

- 8.1 Background 112
- 8.2 Acoustic strategy 115
- 8.3 Floor constructions 119
- 8.4 Wall constructions 122
- 8.5 Junctions and flanking 125

CLT and thermal comfort 131

- 9.1 Thermal mass 131
- 9.2 Design against condensation 132
- 9.3 Thermal insulation 132

Procurement and site works 136

- 10.1 Procurement 136
- 10.2 Preventing moisture damage during construction 136
- 10.3 Delivery, lifting and temporary stability 139

Symbols 142

Bibliography 146

Non-liability and copyright 150

CLT manufacturing mills in Sweden 152

Publications and websites from Swedish Wood 155



CLT as a construction material

- 1.1 Introduction 8
- 1.2 Architect's view of CLT 9
- 1.3 CLT as a construction material 11
- 1.4 CLT in the eco-cycle 12
- 1.5 CLT manufacture 16
 - 1.5.1 Certified CLT 18
- 1.6 Properties 19
 - 1.6.1 Strength properties 19
 - 1.6.2 Thermal properties 19
 - 1.6.3 Moisture-related movement 20
 - 1.6.4 Fire properties 20
 - 1.6.5 Classes and surface treatment 20
- 1.7 Where can you use CLT? 21

1.1 Introduction

Cross-laminated timber, crosslam, CLT and X-Lam are common names for panels made of glued boards or planks layered alternately at right-angles. The terms mass timber and engineered timber are also used, but these refer not only to CLT, but also to glulam and other laminated timber products. For this CLT Handbook, we have decided to use the term cross-laminated timber and the abbreviation CLT. The majority of the CLT in the UK is used in the construction of low to medium rise blocks of flats, schools, nurseries and private houses; it is also starting to be used for other structures, such as offices and sports centres. Since CLT is a versatile product, it can be used in a broad spectrum of applications. CLT is currently used primarily for walls and floors. CLT is an eco-friendly and recyclable construction material that, used correctly, has a long service life. It can then be reused in new structures or incinerated for energy recovery.

The distinguishing feature of CLT structural components, such as walls and floors, is that they are often used as large panels. The opportunity for sizeable cross-sections gives the panels a high load-bearing capacity and stiffness, which also makes them useful for stabilising the building against lateral loads. The panels can be manufactured with a high degree of prefabrication and accuracy, enabling fast construction, and their low self-weight (compared with concrete) has benefits in terms of foundations, transport and assembly. Thermal bridges are avoided because of the insulating properties of timber, and CLT can also provide good fire safety, with appropriate design.

Modern manufacturing techniques, combined with good strength properties, therefore make CLT a valuable construction material with many unique properties:

- The potential for increased prefabrication of buildings.
- High strength in relation to the self-weight of the material.
- Tight manufacturing tolerances and good dimensional stability.
- Inherent fire resistance for a defined period of time, thanks to slow defined rates of charring and the insulating qualities of timber.
- Good thermal insulation.
- Low self-weight, which means lower transport, assembly and foundation costs.
- Ability to tolerate chemically aggressive environments.
- Flexible production, because panels can be made in a wide range of sizes.

CLT structures are characterised by fast and simple assembly of prefabricated panels or modules. The components can be joined using simple traditional methods such as nailing and screwing. For more demanding structures, there are more advanced fixing methods. Like any prefabricated material, a CLT panel has full load-bearing capacity even before assembly and, as with other timber structures, minor changes can be made on-site using simple hand tools.



Alpine refuge, Kebnekaise, Sweden.

Wood has been used in buildings for centuries and is a material with extremely good durability if kept dry. The UK has many examples of wooden buildings that are hundreds of years old, and even one (Greensted Church) that predates the Norman conquest!

1.2 Architect's view of CLT

It is said that forward-looking politicians in the alpine countries of Europe came up with the idea of developing wood for modern construction.

The question was: can we make a construction material from the trees lining our valleys, rather than scraping ballast from the slopes and riverbeds to produce concrete? This question was sent out to the leading universities in Austria and a few years later, in the late 1990s, researchers unveiled Kreuzlagerholz, KLH, or CLT in English. This marked the birth of a new construction material based on a climate-smart and ecological approach. An engineered construction material that makes use of a raw material that is constantly growing and renewable.

Now the world of construction had a material for architecture and urban development that offered an alternative to stone, brick, steel and concrete. Of course, wood is nothing new in building. Frames of vertical and horizontal timber have formed solid walls in homes since time immemorial. Post-and-beam structures, with horizontal beams between posts, were developed when access to logs became commercialised. People have always had an affinity with wood as a construction material, as it can be crafted with all kinds of tools.

CLT allows for large-format wooden panels — it is generally possible to manufacture panels up to 3.6 m wide and 20 m long, with thicknesses of around 60 – 400 mm. This enables architects to design a building that comprises flat packs of prefabricated panels with precision holes cut out for windows, doors and services, which are then assembled on site. We are talking about industrial production, under cover, with time-saving assembly on site. This is also the case with the manufacture of modular units, where floors, walls and ceilings can all be produced in CLT.

CLT is an engineered material that can be used for architecture in an industrialised way, with extensive prefabrication of components. Elements based on wood can be processed all the way to the detailing and surface finish. With modern digital technology offering new choices and incredible precision, the construction world is no longer tied to the site-bound, suboptimal building culture.

CLT furnishes interiors with surfaces that are ready to use. The floor is pleasant to walk on, since wood immediately conveys warmth to bare feet. Shelves can be screwed into the walls without any problem. Pictures can be hung, and things can be fixed to the ceiling with no fuss. If the resident wants to add a doorway, there is usually plenty of freedom to saw a new opening, where appropriate. And adding a new window for extra daylight is generally just as straightforward.

CLT panels perform structurally like concrete components, but with much lower self-weight. For calculation purposes, CLT is a sheet material, with defined strengths.

In the event of a fire, the cross-laminated timber panel chars on the surface to create a protective layer, while retaining structural integrity for a predictable period of time.



Ventilation tower with CLT frame, Stockholm, Sweden.



Arcadia Nursery, Edinburgh, Scotland.



Summer house under construction, Öland, Sweden.

With all the excellent properties that CLT displays, it can be used with confidence as a construction material. People have long put their trust in wood.

A useful option that CLT structures allow is densification, with new developments that slot comfortably into the existing built environment. Newbuilds assembled in kit form can be erected in a short space of time, and this time-saving construction method can be tailored well to local conditions.

Architecture that makes use of CLT can embrace a design language that is exciting and surprising, since wood conveys the spirit that architects and developers want for their projects, in terms of planning, function and appearance. CLT can also be used successfully in conjunction with other materials, such as reinforced concrete.

Such composites can provide answers to structural challenges concerning floor structures. Traditional timber-framed houses show the advantage of combining different materials.

A challenge for the future is to achieve energy-efficient cities with buildings that face the sun and generate their own energy. The fact that CLT forms a climate-smart carbon sink in structures, while allowing attractive solar panels to be mounted on the façade and roof,

is good news for future architecture. And remember that various types of building in the cityscape can be made using CLT construction kits. The housing we need to build for the young and the old, schools, nurseries, offices, sports halls, bus and train stations, shops, hotels and restaurants – all this architecture can be built around CLT.

CLT advances the cause of industrial manufacture using a material that is renewable and easy to work with. It opens the way for an industry equipped with digital power and automation that can be used for products that benefit humanity, bringing diversity and rich experiences to architecture and urban planning. This is an architectural material that embodies our desire to make the planet more sustainable for us, our children and our children's children.

Finally, it has also been shown that people sleep better in rooms that use wood in floors, walls and ceilings – a material that breathes and maintains an active relationship with the seasons and relative humidity. Sustainably.

1.3 CLT as a construction material

Cross-laminated timber, CLT, is a highly engineered wood product that is excellent for all sorts of different structures. CLT's composition and method of manufacture offer huge opportunities, since the panels can be glued and worked into almost any shape and size. Since the raw material is fully renewable, CLT also has a good environmental profile.

Cross-laminated timber has excellent strength and stiffness properties, which means that CLT panels can compete with other more traditional structural materials in low- and medium-rise buildings. In relation to their weight, CLT panels have a higher load-bearing capacity than most other construction materials, which is why large structures can be built to withstand high loads. Since the cross-section can take on any shape and the geometry of the panel can be varied, even occasionally curved, there are extensive opportunities to use wood in a new way. CLT is already being used in many different types of structure: houses, medium rise blocks of flats, sports centres, arenas and offices. With suitable design and detailing, and protection from moisture, CLT can be used for these and many other structures.

CLT was first used in the UK early this century, by which time Central Europe had been manufacturing CLT panels for several years. The first major development in the UK to use CLT was the Kingsdale School sports hall, which was completed in 2007. Since then, the technology has really taken off, so that now Europe is thought to produce over 1M cubic metres of CLT panels per year. Demand for and production of CLT is also rising globally.

Intensive research and development is currently underway regarding design, manufacture and building with CLT. Developers and contractors almost everywhere in the world are also beginning to realise the potential of building in wood. In Vancouver, Amsterdam, Milan and many other cities, many low to medium rise timber buildings are either in the planning or construction phase, and a few projects have even experimented with 20 storeys (although such tall buildings are still very much in the research phase).



Kingsdale School sports hall, London, England.

Volume of manufactured CLT in Europe (m³)

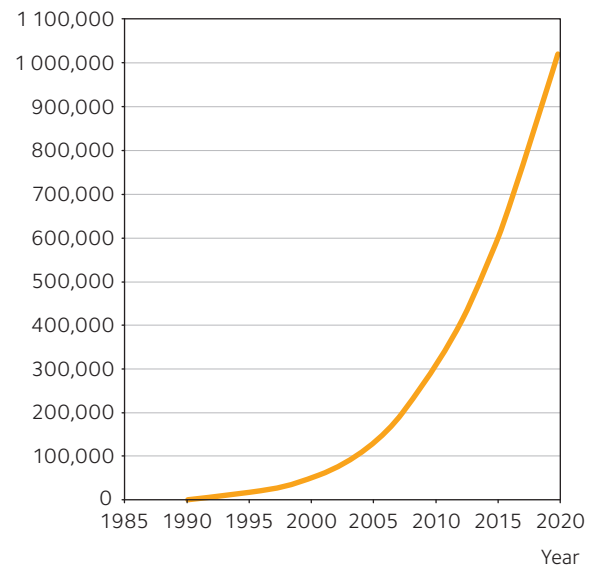

Figure 1.1 Development of CLT in Europe

1990 – 1995	Concepts, patents and proposals presented in European trade journals.
2007	First use of CLT in UK.
2020	CLT production exceeds 1M m ³ .

1.4 CLT in the eco-cycle

European forests are managed according to the principles of sustainable forestry. Use of wood is therefore beneficial from an environmental and climate change point of view, compared with other construction materials. Firstly, manufacturing CLT is an energy-efficient process. Secondly, the by-products (wood shavings and wood waste) are used to produce energy, which is used to heat the drying kilns, for example, thus reducing the need for fossil energy during manufacture. Sustainable forestry means that the extraction from the forest does not exceed growth, the raw material is constantly regenerated, and the wood can be returned to the eco-cycle without adding harmful greenhouse gases to the climate.

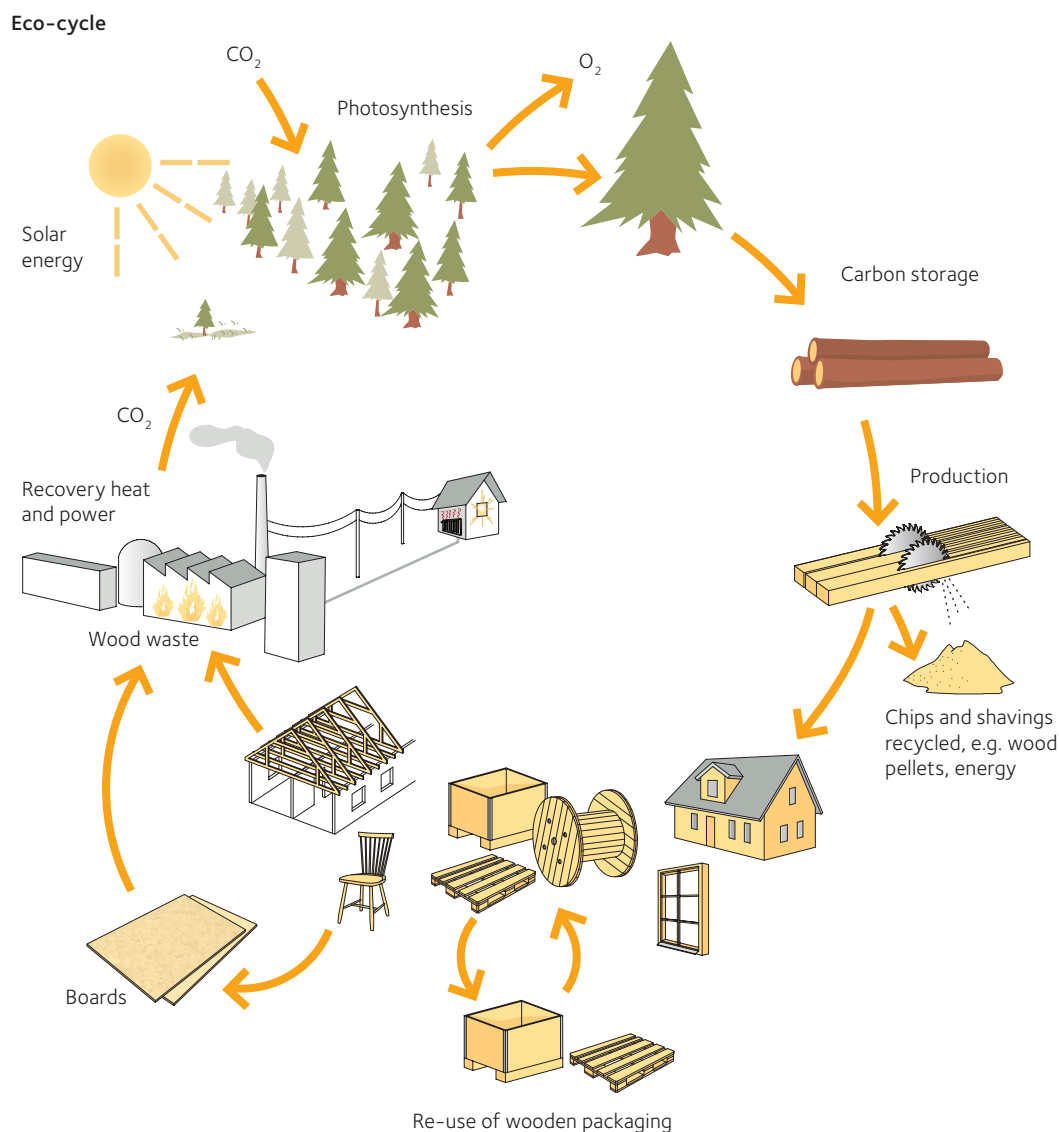

Figure 1.2 Eco-cycle of wood products

The eco-cycle comprises two parts. One relates to the forest and the other to the products. The forest gains its vitality from the sun. Through photosynthesis, solar energy is absorbed and reacts with carbon dioxide (CO₂) to produce nutrients for the growing trees. The forest's products contain carbon (C) that has been absorbed

by the trees in the form of carbon dioxide. The ecocycle of the products includes reuse, repair and recycling. When these products reach the end of their life, the carbon dioxide is released into the atmosphere as the waste decays or is recycled as bioenergy. The carbon dioxide is then again captured by the trees and converted into nutrients and new building blocks for their growth.

Building with wood is positive for the climate. To minimise the environmental impact of construction and to contribute to a sustainable society, every opportunity to use renewable materials must be seized with both hands. For the construction and property sector, this means considering the production and operational phases, both of which affect the environment. As the operational phase has become increasingly energy-efficient, so the manufacturing and construction process has a bigger impact when measuring the environmental impact of a building over its entire life. Life cycle analyses of completed buildings have shown that emissions can be reduced by using a wood structure instead of other materials.

Standards and methods for assessing a building's environmental impact are based mostly around standards such as ISO 9001 and ISO 14001. Then there are the standards for life cycle analyses (LCA). The standards provide a way to measure a building's environmental profile over its lifetime, including construction, use and end of life. *Table 1.1* states which parts of the building's life should be considered when assessing environmental impact.

As part of a European project, several life cycle assessments were carried out on four-storey buildings that used different materials. The buildings used in the study were a site-built lightweight timber frame; an in-situ concrete frame, with timber-frame curtain walls; a modular lightweight timber frame; panellised CLT; and glulam post and beam frame with timber-frame walls. The last three buildings were also designed to meet passive house standards. The impact was measured for the complete building, including the foundations, but excluding interior fittings and lifts.



Spruce plant.

Table 1.1 Environmental assessment of a building

Life cycle information about the building				Other information
A 1-3 Production	A 4-5 Construction	B 1-7 Operation	C 1-4 End of life	D Other environmental information
A1 Raw material A2 Transport A3 Manufacture	A4 Transport A5 Foundation and erection plus installations on site	B1 Use B2 Care and maintenance B3 Repairs B4 Replacement B5 Renovation and retrofitting B6 Energy B7 Water	C1 Demolition C2 Transport C3 Waste management C4 Final processing	Pros and cons outside the system parameters, e.g. environmental certification, energy recovery from wood.
Upstream	Central	Downstream		
Detailed information if possible, otherwise from construction database.	Detailed information about manufacture of carcass, transport to and on construction site, energy use and waste when constructing the building.	B1 – B5 as per appendix with standard times for maintenance and repairs. Energy use from energy calculation C1–C4, scenario for waste management using current methods.		Report any environmental information or other relevant information about the project.

The positive properties of wood

Wood is a natural and renewable material that is produced locally for minimum transport needs. The by-products from production are used to generate energy, and the production process creates minimal waste. The material stores carbon dioxide throughout its lifetime, and at the end of its life it can be used as biofuel to replace fossil fuels (*see figure 1.2* above for an illustration of the potential carbon dioxide release at end of life).

It is possible, for example, to create a lightweight extension on existing foundations, which saves materials, and this is reported in module A. With lightweight movable walls, a retrofit can be completed without any major impact, and this is reported in module B5. And if you can reuse beams or structural elements, that brings considerable savings and can be reported in module D.

Source: Tyréns AB



Spruce forest.

Figure 1.3 presents figures for some of these alternatives with regard to their impact on greenhouse gases in the atmosphere, expressed as carbon dioxide equivalents, in the production phase from raw material extraction all the way to the finished product or component from the factory.

The results show a difference between the three types of timber building, albeit a relatively small one. The emissions are somewhat higher for buildings designed to modern standards, which is probably due mainly to the quantity of insulation used in walls and under the foundation slab, plus the use of more plastics.

The difference between the standard design and the passive house design for the modern alternatives is mainly attributable to an increased amount of insulation.

The building with a concrete frame uses in-situ concrete for the foundations, the floor structure and the load-bearing walls, which explains the significantly higher carbon emissions, while emissions from mineral wool, plasterboard and wood materials are lower than for the wood-based options. The difference in emissions is in the order of 100 kg/m². Translating that to a flat of 100 m², the difference is around 10 tonnes of carbon dioxide (CO₂), or around the same amount as a new car emits from 80,000 – 100,000 km of driving.

A CLT building differs from buildings using traditional concrete and steel techniques, since the wood material contains a large quantity of carbon, which is stored for the entire life of the building.

Figure 1.4, page 15, shows the calculation of emissions for the other life cycle phases too, as well as emissions from energy consumption for heating and hot water over 100 years of the building's operation. The concrete alternative also stores large quantities of carbon in

Carbon emissions (kg CO₂eq/m² housing development)

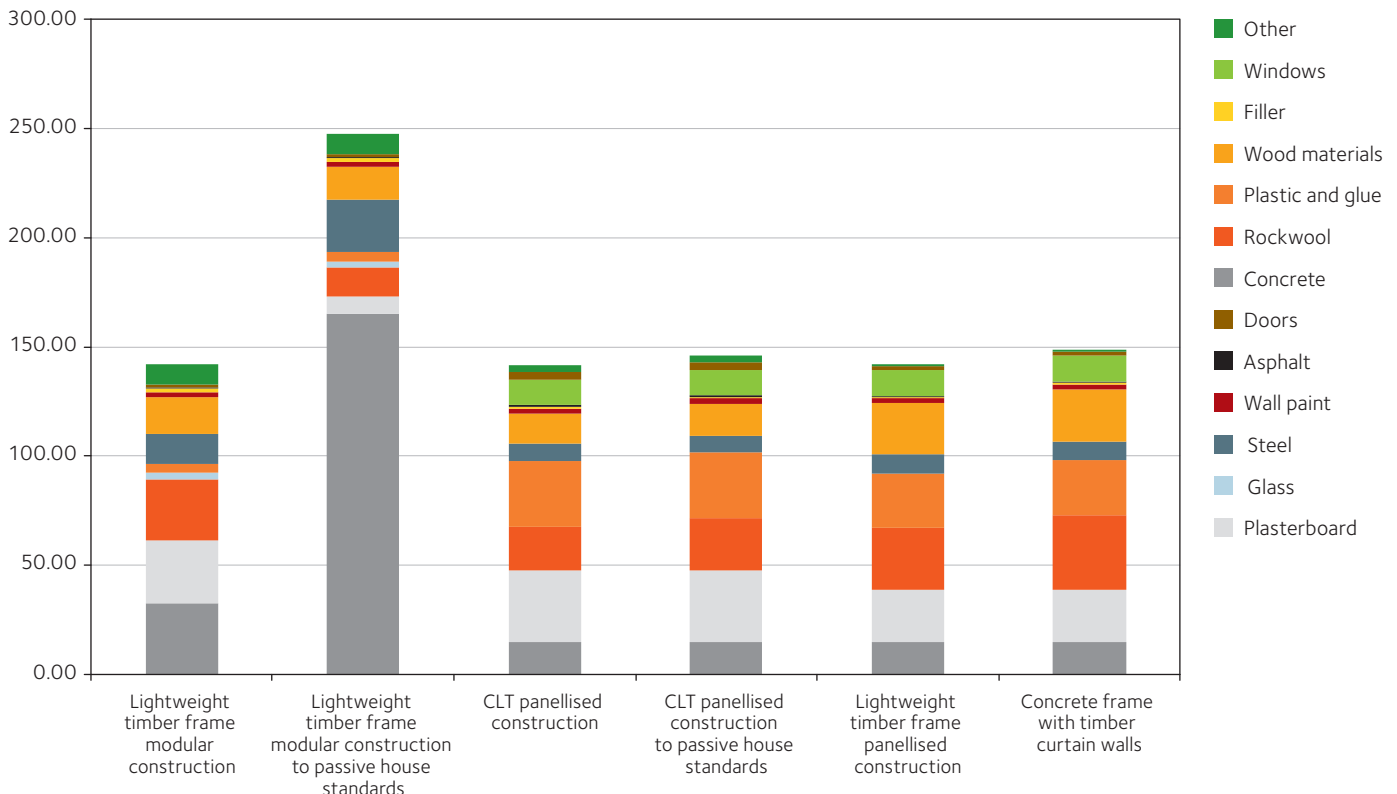

Figure 1.3 Greenhouse gas emissions (carbon dioxide equivalents, CO₂ eq) from the production phase for six different designs of a four-storey building

the wooden components, for example in the wooden structure of the curtain walls, fixtures and interior wood surfaces. Another factor to bear in mind is that, at the demolition stage, the wood material can be used as energy. *Figure 1.4* shows the amount of emissions that can be avoided if one assumes that the wood material replaces coal in energy production.

The bar chart, *see figure 1.4*, also indicates major differences between buildings that meet the passive house standard and “normal” buildings. The parameters that are assumed to be different are amount of insulation, better airtightness and more low-energy lighting etc.

The carbon emission calculations were made in Sweden and therefore assume that there is a district heating system based largely on bioenergy. In this scenario, emissions from 100 years of operation are the same size as in the production phase for passive houses and around two to three times the size for the other buildings. The calculation also considers the difference that arises from differing thermal inertia of the various structural frames, but with all of them having the same U-value in the building envelope and otherwise being assumed to be the same, the difference is marginal for residential buildings. Finally, the absorption of carbon dioxide during the building’s operational phase through carbonation of the concrete is also included.

A crucial factor for a building’s environmental impact is the service life of the building and its constituent parts. In this case, the assumption has been that there is no difference between the different alternatives with regard to service life or intervals for renovation, maintenance and replacement of materials and components. The judgement has been made that the overall differences lie in the structural frame, which is not expected to require any maintenance over the life of the building, while all exterior and interior surface finishes have been assumed to be the same for each alternative.



Trafalgar Place apartments, London, England.

Carbon emissions (kg CO₂eq/m² housing development)

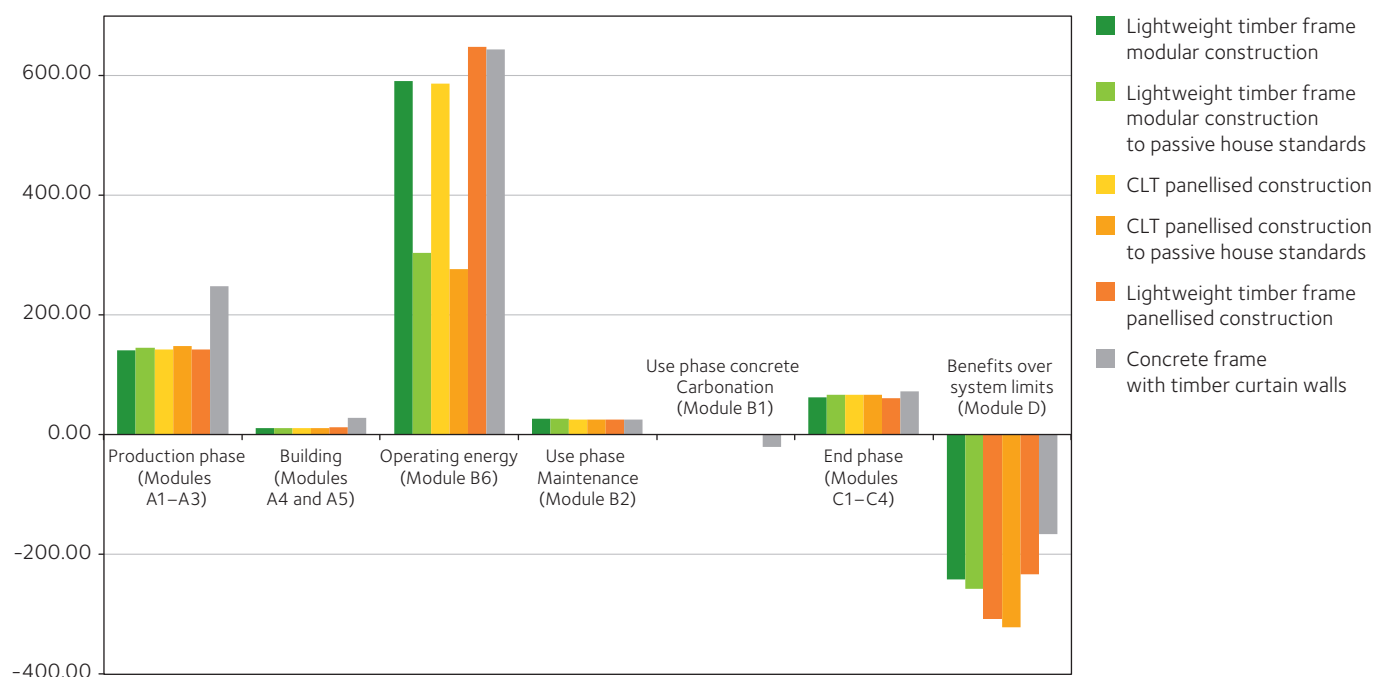

Figure 1.4 Greenhouse gas emissions (carbon dioxide equivalents, CO₂ eq) from the building’s life cycle for six different designs of a four-storey building. The two end columns represent alternative scenarios regarding end use of the wood material.

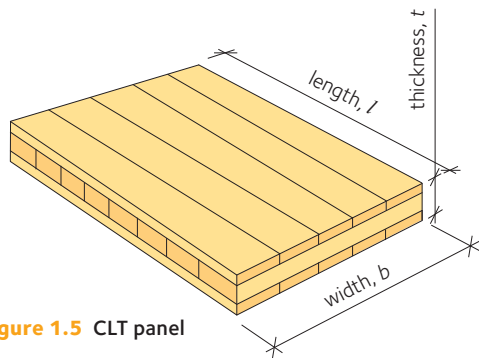

Figure 1.5 CLT panel

1.5 CLT manufacture

CLT is a construction material comprising at least three layers of glued boards or planks made from coniferous or deciduous wood, with each layer placed at 90 degrees to the next. CLT is manufactured to standard BS-EN 16351 and has to comply with the product properties that the CLT manufacturer has declared in its European Technical Approval, ETA.

Table 1.2 Common strength classes and dimensions of boards and planks used to manufacture CLT

Parameter	Commonplace	Available
Thickness, t	20 – 45 mm	20 – 60 mm
Width, b	80 – 200 mm	40 – 300 mm
Strength class	C14 – C30	–
Width to thickness ratio	4:1	–

Table 1.3 Common dimensions for CLT panels. Parameters see also figure 1.5.

Parameter	Commonplace	Available
Thickness, t	80 – 300 mm	60 – 500 mm
Width, w	1.20 – 3.60 m	up to 4.80 m
Length, l	20 m	up to 30 m
No. of layers	3, 5, 7, 9	up to 25



CLT panels ready for packaging and delivery.

CLT panels are made up of boards or planks with a thickness of 20 – 60 mm. These boards and planks also go by the name of laminates or lamellae, but *the CLT Handbook* will continue to use the general term board. The raw material is timber that has been strength-graded to standard BS-EN 14081-1. Each CLT manufacturer has its own standard thicknesses and strength classes. Similarly, the cross-section and the orientation of the layers differ from manufacturer to manufacturer. Spruce and pine are the most commonly used species. The timber tends to be delivered dried and strength-graded direct from the sawmill.

The moisture content in the boards must be between 8 % and 15 % when they are glued together, with the precise level determined by the glue being used and the end use of the product. The moisture content must not vary by more than around 5 % between adjacent boards. The strength of the bond is best when the moisture content is close to the equilibrium value in the finished structure, which also minimises any splitting in the wood. A certain amount of splitting is unavoidable in wood, and it generally has no harmful effect on the structural performance of the panel.

The cross-section of CLT usually comprises boards of the same strength class in the main direction of the load. To make best use of the timber's strength, wood of higher strength is commonly used in the outer layers in the main spanning direction, where the stresses are normally greatest. During manufacture, it is therefore necessary to have the space to store boards of at least two different strength classes at the same time.

The manufacture of CLT uses more or less the same process, see figure 1.6, page 17, no matter where it is made or by whom.

Firstly, the individual boards are finger-jointed to create long boards. Once the glue in the finger joints has hardened, the flat sides of the boards are planed and then immediately sent for gluing into panels. The batches of boards are transferred to the gluing line and assembled into large sheets that are glued together under pressure. The glue then needs to harden for a set time, which depends on the type of glue and the temperature and moisture conditions in the gluing hall. The compression uses two main methods: vacuum and hydraulic. Vacuum compression provides a steady pressure, even on non-level surfaces, but the pressure is low.

Hydraulic compression may involve cold or hot pressing. After the gluing comes the final finishing of the components in a CNC machine, which may involve sawing edges, milling channels for installations, drilling holes and preparing for joints and fixings. The visible surfaces of each panel are sanded, and finally the components are checked visually and labelled before they are packaged and loaded up for transport to the construction site.



Finishing a CLT panel in a CNC machine, CNC = Computer Numerical Control.

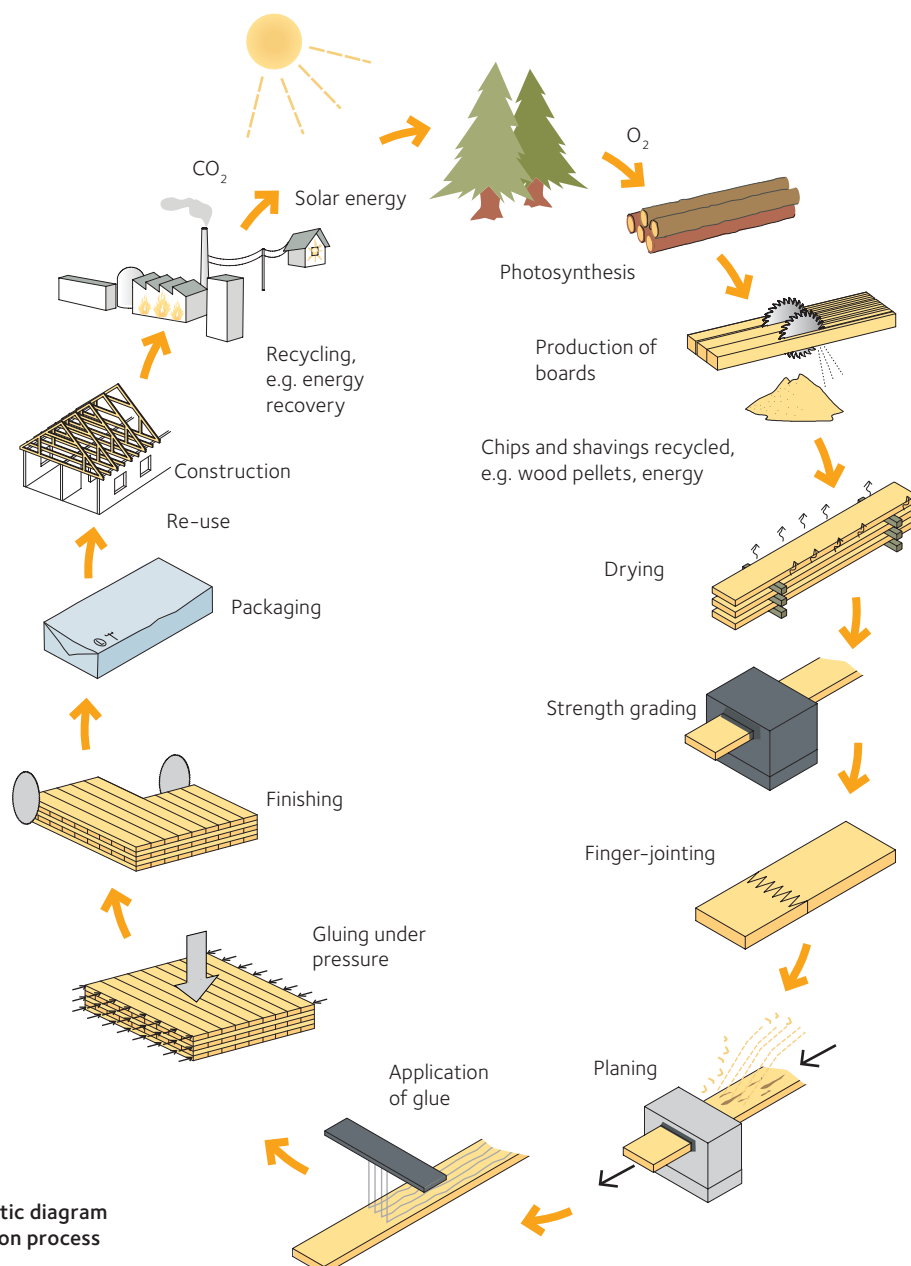
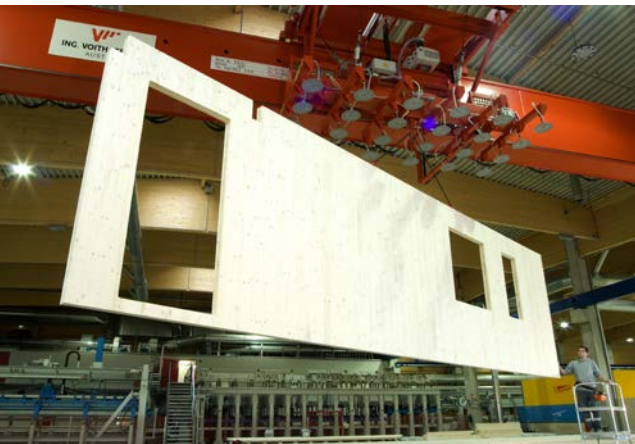

Figure 1.6 Schematic diagram of the CLT production process



Manufacturing of CLT wall.



The CE mark is a product label within the EU.



The UK CA mark.

1.5.1 Certified CLT

Suppliers of construction products must be able to verify the properties that they claim apply to their products, so that buyers can be confident that the products are compliant. To ensure this, an increasing number of construction products are now certified. As a result of European standardisation, the certification process has been the same in all European countries. The UK's exit from the EU may result in some divergence in the future, but at the present time all suppliers are working from the same established European technical standards.

Certified CLT is CLT that has been manufactured under controlled conditions and whose properties have been verified. The finger-jointing technique allows for the manufacture of very large panels, with the size and length limited firstly by the transport and secondly by the factory and equipment. Manufacturing CLT requires considerable precision, not least regarding the milling of the finger-joints, glue preparation and application, pressure and timing. For CLT, gluing is usually the critical factor in ensuring the requisite quality and strength. The quality of the glued finger-joints and layers is therefore constantly monitored. In-house controls take place on a rolling basis to ensure that the products maintain consistent, high quality; this involves taking regular samples to check for strength and delamination. These internal controls are verified by an approved third-party.

An accredited control body issues certification, and checks and verifies the company's internal controls, making unannounced inspection visits to manufacturers.

CLT panels have been in use since the late 1990s, and a number of companies have certified their products in accordance with the European Technical Assessment (ETA). An ETA is a precursor to a harmonised standard in that it contains instructions on verification procedures, for example for certification, type approval and control of manufacturing. Work has been underway to create a harmonised standard for CLT based on these original ETAs and this document was published in the Official EU Journal in March 2020 as EN 16351 Timber structures – Cross laminated timber – Requirements, which means it can now start to be used as the established European technical standard to facilitate CE marking.

The CE mark is a product label within the EU. A product that carries the CE mark may be sold in the European Economic Area (EEA – the 28 EU countries plus Norway, Iceland and Liechtenstein) without any additional documentation. The CE mark on a product shows that the manufacturer has complied with the basic requirements set out in the EU directives that govern this area. The UK will in future be using its own UK CA mark as an alternative to CE marking to show that construction products are UK Conformity Assured. It is too early at this stage to determine if there will be a single route for certification in the UK that all EU CLT manufacturers will follow in future, but in the short term we will have a choice of routes.

1.6 Properties

1.6.1 Strength properties

CLT has major similarities with other wood products in terms of its strength properties:

- The strength varies according to the angle between the applied stress and the fibre direction, making it an orthotropic material.
- The strength falls slightly as the moisture content rises.
- The strength falls as the length of time under load rises.
- Being a natural material, the material properties vary both within one component and between different components.

The structure of CLT, with its perpendicular layered boards, evens out the natural variations in the wood and reduces the property differences. The strength of CLT is determined to a large extent by the layering of the cross-section. For CLT, the tensile strength of the outer boards and the rolling shear strength of the transverse layers are crucial in determining the ultimate strength. For serviceability, the layering of the cross-section is even more important in terms of what stiffness can be achieved. Compared to stress-laminated timber decks, which are often used in bridge designs in Scandinavia and the USA, CLT exhibits lower stiffness in the main direction of load for panels of the same thickness. A CLT panel can, however, resist substantially higher loads perpendicular to the main spanning direction.

The basis for the static design of CLT and wooden structures in general is a characteristic strength or stiffness value, determined via testing under laboratory conditions and via a set number of samples. Normally, strength calculations in a design are based on the lower 5 % fractile, which is the value that is statistically undershot in 5 cases out of 100. Knowing the characteristic strength value, the design value for the individual case is then determined using various partial coefficients and conversion factors. Characteristic stiffness values, such as modulus of elasticity and shear modulus, are determined in a similar way, but taking the average value as the starting point, rather than the 5 % fractile.

1.6.2 Thermal properties

Wood has very small temperature movements, compared with many other materials. The thermal conductivity and thermal capacity of CLT is practically the same as for solid wood. The thermal conductivity, which describes the material's insulating capacity, is significantly better than for concrete and steel. The practical value for thermal conductivity for spruce is $0.11 \text{ W/(m } ^\circ\text{C)}$ perpendicular to the fibres and $0.24 \text{ W/(m } ^\circ\text{C)}$ parallel to the fibres, while for pine the equivalent values are $0.12 \text{ W/(m } ^\circ\text{C)}$ and $0.26 \text{ W/(m } ^\circ\text{C)}$, respectively. In practice, a value of $0.12 - 0.13 \text{ W/(m } ^\circ\text{C)}$ tends to be used for CLT. CLT also has a reasonable amount of thermal mass compared with lighter-weight walling systems.



Strength-testing of CLT.

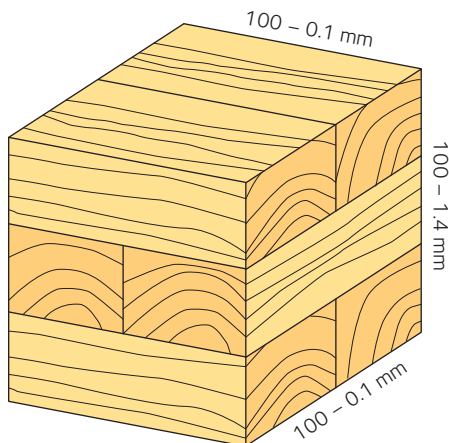

Figure 1.7 Approximate contraction of a CLT panel per 100 mm when drying from 20 % to 10 % moisture content

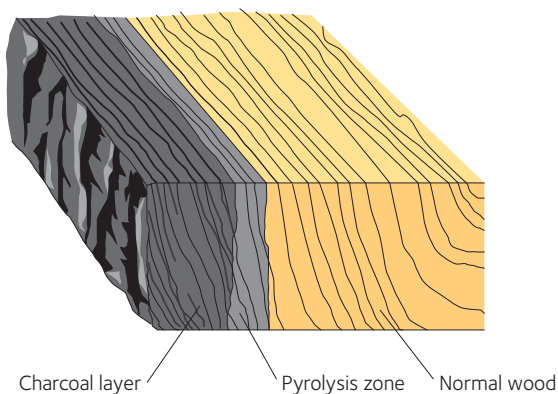

Figure 1.8 Fire penetration

1.6.3 Moisture-related movement

CLT expands perpendicular to grain when the moisture content increases, and contracts when the moisture content falls. The alternating layers of boards mean, however, that the wood in CLT panels expands and contracts in the plane of the panel less than ordinary solid wood. CLT is manufactured under controlled conditions from boards and planks with a moisture content of between 6 % and 15 %. The question of how much less the expansion and contraction will be compared with ordinary solid wood is determined by the number and thickness of the layers. Products made from CLT are usually manufactured with a target moisture content of 12 %. This means that individual CLT products will have a moisture content of no more than 16 % on delivery. The moisture content of CLT will gradually achieve equilibrium with the ambient relative humidity (RH) and follow its variation over the year. Depending on where the building is located, where the CLT is in the building, and whether the building is heated, the moisture content can vary by up to 4 % over the year.

An uninsulated CLT panel placed in a roof or outer wall will be subject to varying moisture conditions – warm and dry on the inside and cold and damp on the outside – which means that the component may tend to expand on the outside and contract on the inside, taking on a bowed shape. This is a peculiarity that the structural engineer should bear in mind at the planning stage.

1.6.4 Fire properties

CLT and structures made from CLT have good, predictable properties when it comes to fire. CLT is a flammable material, but in combination with other materials, the required load-bearing capacity can be maintained during the fire. Wood is slow to catch fire and it burns slowly. The way the heat develops during a fire is often crucial in determining whether the fire will spread or burn out. The charcoal layer that forms on the surface of CLT in a fire protects the inner parts, and the penetration rate for wood made with heat resistant glues is generally around 0.6 – 1.1 mm per minute. You can read more about how to design for fire, load factors and how further fire protection can be achieved with supplementary layers in *Chapter 7, CLT and fire safety*, page 98.



1.6.5 Classes and surface treatment

CLT panels are primarily considered structural components whose key properties are strength, stiffness and durability. Standard products meet normal appearance requirements, as long as they are handled with sufficient care in transit and during construction.

When the CLT panels are taken out of the glue press, they have minor irregularities along the sides, which are duly removed. The smooth surface is usually of sufficient quality that further finishing is not required.

If the design specifies exposed surfaces, boards should be chosen based on the requirements placed on the surfaces. Most CLT manufacturers have a few different appearance classes to choose from and different ways of naming these, such as Exposed surface, Industrial surface and Non-exposed surface. CLT panels can then be surface-treated on site just like ordinary wood, using woodstains, paints, varnishes or oils. *Table 1.4, page 21*, shows examples of what may occur and what is not permitted for different appearance classes.

Table 1.4 Appearance classes, example

Appearance class	May occur	Not permitted	Example of surface
Exposed surface	Few pitch pockets under 3 x 40 mm ² Black knot less than 10 mm Sound knot less than 10 mm	Enclosed bark, open scars, firm/soft rot, pith, insect attack, wane, knot holes, decayed knots, encased knots, notches, splits (not seasoning checks), visible glue	
Industrial surface	Few pitch pockets under 3 x 40 mm ² Black knot less than 20 mm Dead knot less than 20 mm Sound knot, pith, knot hole, minor occurrence of notches, visible glue	Bark-encased scars, open scars, firm/soft rot, insect attack, wane, decayed knots, encased knots, splits (not seasoning checks), eye-catching knot clusters	
Not exposed surface	Pitch pockets, knot holes, black knots, decayed knots, dead knots, notches, encased knots, sound knots, pith, splits, insect attack, visible glue, colour differences between boards, blue stain to a lesser extent.	Firm rot, soft rot	

1.7 Where can you use CLT?

Wood is an eco-friendly and recyclable construction material that, used correctly, has a long service life. It can be reused in new structures or incinerated for energy recovery. Wood is light in relation to its strength, as well as being easy to handle and work with. Wood has a good capacity for thermal insulation. Structural components made from CLT are used primarily for walls and floors, but CLT panels may be used for a wide range of different applications, from small to large scale.

The characteristic feature of structural components in CLT – for walls and floors – is their size. Large cross-sectional areas ensure that CLT components have a high load-bearing capacity and stiffness, making them suitable for stabilising the building. The panels are available with a high degree of prefabrication, and their low weight brings benefits in terms of groundwork, transport and assembly. Making openings and attaching fixings is simple and straightforward. The insulation layer in an outer wall runs all the way through, with no thermal bridges. The solid structure and the cladding material can also provide good fire safety with appropriate design. CLT frames are light in comparison with frames made of concrete, for example; to achieve good sound insulation in floors and walls, additional layers must therefore be added.

The low weight of CLT panels makes them significantly easier to handle than concrete panels. Fixings and foundations are also made easier, which is of benefit when redeveloping existing buildings. Mezzanine floors made from CLT are often a good choice, as they allow older industrial buildings with high ceilings to be divided up into several storeys.

Due to the low weight of CLT, reconstruction can often be carried out without strengthening the foundations. Another advantage of the low weight is transport and lifting during construction. A CLT frame is also



Example of a roof structure with load-bearing and stabilising CLT panels, which also contribute to a good indoor climate. Wintringham Academy, St Neots, England.

1.7 Where can you use CLT?



Pitfield Street apartments, London, England.

a good option for urban densification projects and vertical extensions to existing buildings for the same reason, and because CLT can handle large spans.

Wood is sometimes the only sustainable alternative in certain contexts, such as buildings where the material is exposed to an aggressive environment or where the mechanical wear is too much for other materials.

To prevent flames from spreading along the ceiling, the wooden surface can be protected on the underside with a fireproofing paint, for example. Beams or screens angled downwards can also slow the spread of fire and smoke across the ceiling.

CLT offers infinite possibilities, limited only by the designer's imagination. Everything from the boards around an indoor riding arena to large stairwells or ventilation towers are examples where CLT panels are the ideal, and sometimes only reasonable, choice.

CLT panels have the specific ability to combine load-bearing capacity and finishes, which means that the product can be used for balustrades and screens in environments where the surface material is subject to major mechanical wear.



Pier, Hastings, England.





Indoor riding arena with walls and boards in CLT, Sättra, Sweden.

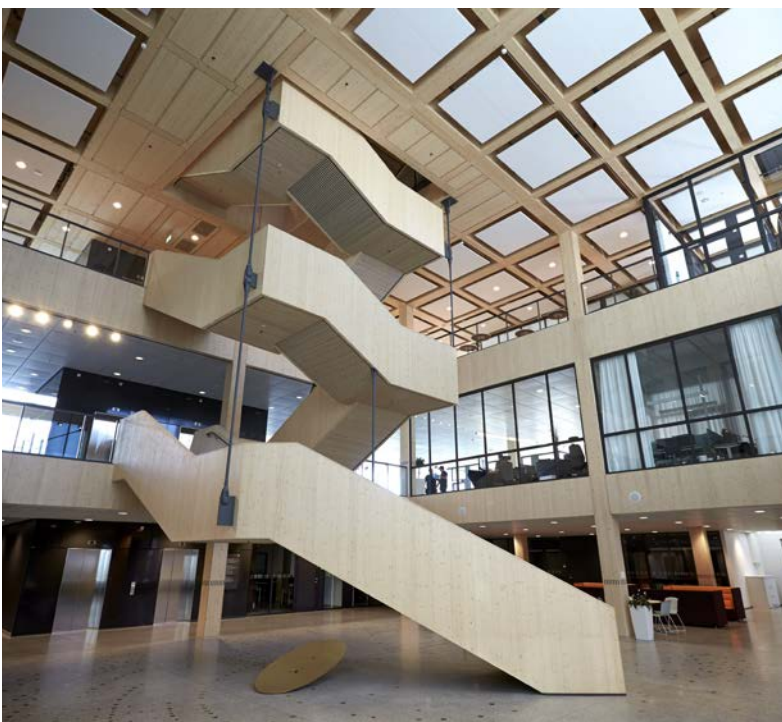

Ulls Hus, Uppsala, Sweden.



Stepped ledges provide standing room or seating, forming stands in sports venues and halls, Järfälla, Sweden.

Basis of design of CLT structures

2.1 Basis of design 24

- 2.1.1 Loads 25
- 2.1.2 Load duration and service class 26
- 2.1.3 Moisture-related movement 27
- 2.1.4 Design resistance and stiffness 28
- 2.1.5 Partial factor and modification factors 29
- 2.1.6 System effects 30

2.2 Material properties of CLT 31

The basic principle when designing structures using the partial factor method is to verify that the design value for load effect E_d for a specific structural component is less than the design value for the resistance R_d :

$$E_d \leq R_d$$

where:

E_d is the design value of the effect of actions such as internal force, moment or a vector representing several internal forces or moments.

R_d is the design value of the corresponding resistance.

2.1 Basis of design

Eurocodes have been used in Europe since about 2010. New Eurocodes are expected to be in place by about 2025 that will include the design of CLT. Design methods are currently being refined and developed via bodies such as the European Committee for Standardization (CEN) and its working groups.

Currently, designers of CLT structures can choose between two options: either design the cross-section based on the properties of the laminates in the CLT, or use the tables of properties drawn up and published by the CLT manufacturers and included in the relevant ETA (European Technical Assessment).

Since the structural behaviour often differs between normal use and under loads close to failure, designs need to be checked for both the ultimate limit state and the serviceability limit state. The limit state means the state in which a structure or part of a structure just meets the set requirements.

When designing in the ultimate limit state, the structure must have a comfortable margin against failure if it is used in the manner it was designed for. Eurocode 0 defines what is considered a comfortable margin. For the serviceability limit state, Eurocode 5 makes recommendations, but it is left to the client and their engineers to agree what is acceptable.

The risk of achieving a certain limit state, for example a failure in the structure, depends on uncertainties, such as:

- the probability of the assumed loads being exceeded.
- the probability that the load-bearing capacity has been overestimated.

Normally, both the external effect of loads and the structure's load-bearing capacity can be seen as random variables. If you know the distribution functions for these variables, it is therefore possible to calculate the failure risk with the help of probability theory. Knowledge of these distribution functions is, however, inadequate, particularly for the extremities, which are often crucial for the results.

In practice, this means using different standard functions, usually the normal distribution and the Weibull distribution. As the failure risk calculated in this way becomes purely theoretical, the method is thus not useful for practical design. Although probability theory methods may not be practical for designing in an individual case, they can be useful for comparisons, for example between different materials or between different design types. Probability theory is therefore useful as a tool to help calibrate other, simpler methods, such as the partial factor method.

Design rules for load-bearing buildings focus in the first instance on limiting the risk of a failure. In addition, there is a desire to ensure that the building works satisfactorily in normal use.

The building codes specify the acceptable verification methods, i.e. the methods for establishing compliance with the set requirements. The codes also state the loads, strength and so on to be used in the design.

Just like other construction materials, CLT structures are designed in line with prevailing standards. The Building Regulations point towards the Eurocodes for verification of structural resistance, serviceability and durability. The UK National Annexes to the Eurocodes set out the nationally selected parameters for the application of the Eurocodes. The national choices are based, for example, on varying national factors relating to geology, climate, lifestyle and safety levels. The Eurocodes are based on the partial factor method. This method states that the structures should be checked for two limit states: the ultimate limit state and the serviceability limit state. In the ultimate limit state, the structures are checked to ensure that they are sufficiently safe against failure. In the serviceability limit state, the structures are checked to ensure that they do not suffer deformations of such a scale that they fail to meet the performance levels required from the structures. Checks also need to be made for the dynamic performance of floors.

Designing in line with the Eurocodes assumes that:

- The structures are designed by qualified and experienced engineers.
- Factories and construction sites are subject to proper manufacturing controls.
- The materials and products are used in accordance with the Eurocodes, harmonised product standard or ETA.
- The extent and intervals of building maintenance are appropriate for the intended performance and service life.
- The building is used in accordance with the design assumptions.

2.1.1 Loads

A structure is usually designed not just for one load, but for different load combinations. A leading action (with its full value) is combined with other potential interacting actions (with reduced values) to obtain the design load case.



Elefantenpark, Zürich, Switzerland.



Erection of walls made of CLT, Bromma Blocks, Stockholm, Sweden.

Reduced loads are obtained by reducing the characteristic value Q by the factors ψ_0 , ψ_1 and ψ_2 , which are described as follows:

- The combination value ($\psi_0 Q$) is used for verification of the ultimate limit state and also for the characteristic combination for an irreversible serviceability limit state (where the consequences of the loads exceeding a certain serviceability limit continue once the loads have ceased to be applied).
- The frequent value ($\psi_1 Q$) is used for verification of the ultimate limit state for accidental loads and also for reversible serviceability limit states. The frequent value is exceeded about 1 percent of the time.
- The quasi-permanent value ($\psi_2 Q$) is used to estimate long-term actions in the serviceability limit state, such as creep deflection or splitting, and to take account of variable loads in accidental combinations in the ultimate limit state. The quasi-permanent value equates to the average variable load.

The factor ψ_2 can also be used to convert short-term actions to equivalent permanent actions when designing for long-term effects such as creep. BS-EN 1990 defines combination rules for loads for different design situations, and the UK National Annex states the nationally adopted values for the UK. The following general *equation 2.1* applies, for example, to the design of permanent or temporary design situations in the ultimate limit state:

$$2.1 \quad E_d = \sum_{j \geq 1} G_{k,j} \gamma_{G,j} + Q_{k,1} \gamma_{Q,1} + \sum_{i > 1} Q_{k,i} \psi_{0,i} \gamma_{Q,i}$$

where:

- $G_{k,j}$ is the characteristic value for the permanent action j .
- $\gamma_{G,j}$ is the partial factor for the permanent action j .
- $Q_{k,1}$ is the characteristic value for a variable leading action 1.
- $\gamma_{Q,1}$ is the partial factor relating to $Q_{k,1}$.
- $Q_{k,i}$ is the characteristic value for the interacting variable action i .
- $\psi_{0,i}$ is the reduction factor for the combination value for the variable action i .
- $\gamma_{Q,i}$ is the partial factor for the variable action i .

2.1.2 Load duration and service class

The stiffness and load-bearing capacity of a timber structure is dependent to a high degree on the duration of the loads that act on the structure. During the design process, a distinction is therefore made between loads of different duration, for example permanent actions such as self-weight, and actions with a variable intensity over the lifetime of the building, such as imposed load. The imposed loads are normally divided into long-, medium- and short-term actions. Sometimes accidental actions, such as impacts, also occur. Eurocode 5 gives modification factors for strength based on the load duration.

Strength is calculated based on the material properties applicable to the action (in a combination of actions) that has the shortest duration. Deflection is calculated as the sum of the deflection contributions from the constituent actions, each calculated based on the duration of the individual load.

The load duration class to which a load should be assigned depends to a certain extent on geographic, climatic and cultural differences. Snow load is, for example, considered a long-term or medium-term

action in Scandinavia, while the UK and much of the rest of Europe treat snow load as a short-term action.

Like the load duration, the moisture content of the wood has a major impact on the material's strength and stiffness. Dry wood is both stronger and stiffer than damp wood. The Code handles this by defining several service classes, each defined by a particular range of moisture content that is typical for buildings. The Code gives modification factors for the strength and stiffness values, based on a combination of the load duration class and the service class. The final moisture content of the wood in a structure is determined by its surroundings, temperature and relative humidity (RH), which will also vary over the service life of the structure, *see figure 2.1*.

It is the structural engineer's task, for each project or part of a project, to determine which service class a structural component should be assigned to. This Handbook provides guidance by giving examples for common components.

Service class 1 is characterised by an environment where the relative humidity (RH) exceeds 65 % for only a few weeks per year. This equates to an average moisture content in the CLT that only exceeds 12 % for short periods.

Components in this class include:

- Internal walls and floors
- Warm roofs (within the insulation).

Service class 2 is characterised by an environment where the relative humidity (RH) exceeds 85 % for only a few weeks per year. This equates to an average moisture content in the CLT that only exceeds 20 % for short periods.

Components in this class include:

- External walls
- Ground floors
- Cold roofs.

Service class 3 is characterised by an environment that gives a moisture content that exceeds the level in service class 2.

This class includes, for example:

- Members that are exposed to the rain, condensation or ground moisture.

CLT panels manufactured to the standards of the CE Mark are not intended for use in service class 3, *see also section 2.1.5, page 29*. This is because they do not have adequate durability, and also because the moisture movements could damage the gluelines.

2.1.3 Moisture-related movement

When the wood's moisture content changes, its volume also changes. The wood either swells or shrinks. This dimensional change differs in the different directions in the wood. It is negligible parallel to the grain, greatest in the tangential direction and somewhat less in the radial direction, *see table 2.1*.

Because of this, it is important for timber members to be installed at a moisture content as close as possible to the environment in the finished building.

CLT has more or less the same moisture-related movement as plywood. Depending on how great a proportion of the fibres are oriented in each direction, the swelling or shrinkage in the CLT panel's plane

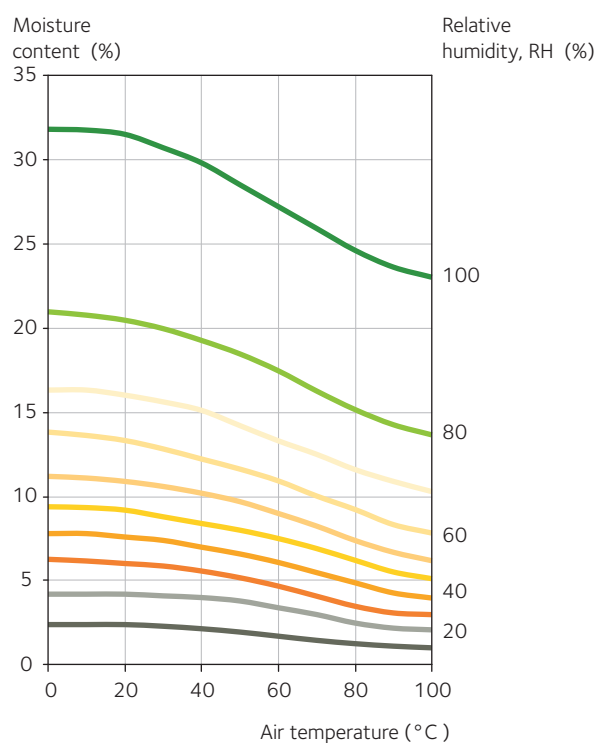

Figure 2.1 The equilibrium moisture content in wood as a function of temperature at different relative humidity (RH) levels.

Table 2.1 Moisture-related dimensional changes in wood

Material: Pine and spruce	Percentage dimensional change for a 1 % change in moisture content
Parallel to grain	0.01 – 0.02
In radial direction	0.19
In tangential direction	0.36
Average across the grain	0.24



Single family house made of CLT, Skara, Sweden.



Stair with handrail milled in the CLT wall panel.

will amount to around 0.016 – 0.023 % per percentage change in the moisture content, which is negligibly more than for wood parallel to the grain. *See also section 1.6.3, page 20.*

2.1.4 Design resistance and stiffness

Designing in the ultimate limit state

Design resistance in the ultimate limit state is determined based on a strength design value. This is calculated by dividing the characteristic value f_k , adjusted by k_{mod} to account for the load duration and service class, and the partial factor γ_M to account for uncertainty in the material:

$$2.2 \quad f_d = \frac{k_{mod} \cdot f_k}{\gamma_M}$$

where:

f_k is the characteristic strength value.

k_{mod} is a modification factor that takes account of service class and load duration, *see table 2.2, page 29.*

γ_M is a partial factor for material properties.

The modification factor k_{mod} is determined based on the duration of the shortest lasting action in the design load combination.

Designing in the serviceability limit state

When designing in the serviceability limit state, it must be demonstrated that the structure has sufficient stiffness to ensure that unwanted vibrations or deformations that degrade the building component's function do not occur.

Since we are normally more interested in an accurate estimate of the size of the deformation than on a value that is most likely to lie on the safe side, average values of stiffness are used in the serviceability limit state.

The Eurocode states that if the loadcase comprises multiple actions of different load durations, the deformation is calculated as the sum of the deformations from the different actions. Each of the contributions is calculated using the material values corresponding to the load duration of the respective actions. The result is then divided by the partial factor γ_M for uncertainties in the material. As a rule, $\gamma_M = 1.0$ is the value used when designing in the serviceability limit state.

When calculating deformations in the serviceability limit state for structures comprising parts or components with different time-dependency, the mean value for the final modulus of elasticity, $E_{mean,fin}$, the shear modulus, $G_{mean,fin}$, and the slip modulus, $K_{ser,fin}$, are calculated with the help of the following expressions:

$$2.3 \quad E_{mean,fin} = \frac{E_{mean}}{(1 + k_{def})}$$

$$2.4 \quad G_{mean,fin} = \frac{G_{mean}}{(1 + k_{def})}$$

$$2.5 \quad K_{ser,fin} = \frac{K_{ser}}{(1 + k_{def})}$$

where:

- E_{mean} is the mean value of the modulus of elasticity.
- G_{mean} is the mean value of the shear modulus.
- K_{ser} is the slip modulus.
- k_{def} is a modification factor for creep deformation that takes account of the service class.

2.1.5 Partial factor and modification factors

The partial factor γ_M depends in part on the degree of control during design and manufacture, but also on the material's homogeneity. The value of the partial factor γ_M for material properties is stated in the national annex to Eurocode 5 and differs from country to country. Because CLT is not yet covered by Eurocode 5, reference should be made to the manufacturer's ETA; the value for glulam is usually taken (which is 1.25 in the UK).

The next generation of Eurocodes will provide more in-depth calculation rules for CLT structures, and thus the material factors and factors for CLT will be more harmonised among the different countries. CLT is not currently used in environments with higher moisture levels than those that occur in service classes 1 and 2. Moisture affects CLT panels by causing local deformations, swelling and shrinkage, which can both damage the gluelines and result in splitting, and so have a negative impact on the CLT's load-bearing capacity and on joints and fixings.

When it comes to load duration, tests show similar behaviours for CLT as for glulam and structural timber. It is therefore appropriate to assume that the modification factor k_{mod} is the same for CLT as for glulam and structural timber, *see table 2.2*.

The modification factor for deformation, k_{def} , depends on the service class, and affects the properties of CLT panels, *see table 2.3*. This factor is usually stated in the CLT manufacturer's data sheet or European Technical Approval (ETA).

Table 2.2 Proposed values of k_{mod} for CLT

Service class	Load-duration class				
	Permanent (P)	Long term (L)	Medium term (M)	Short term (S)	Instantaneous (I)
1	0.6	0.7	0.8	0.9	1.1
2	0.6	0.7	0.8	0.9	1.1
3	–	–	–	–	–

Table 2.3 Values of k_{def} for CLT

Service class	Deformation modification factors, k_{def}
1	0.8
2	1.0
3	–



Boards for the production of CLT.

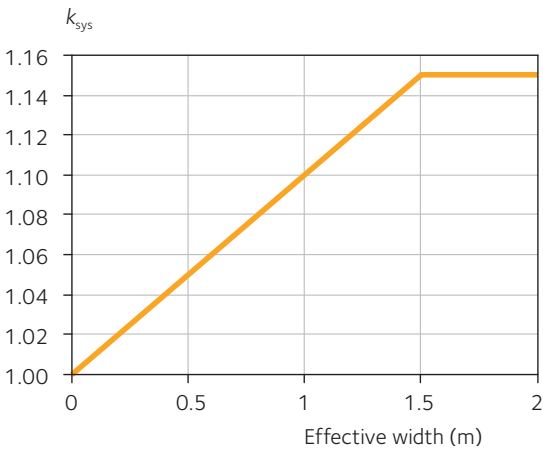

Figure 2.2 System strength factor k_{sys} for CLT for different effective widths

2.1.6 System effects

Compared with components made from solid timber, the equivalent components in CLT have greater average strength and less of a spread of strength values. The strength of structural timber is determined by the weakest cross-section, which is usually at a knot, finger-joint or similar irregularity. The variation between different pieces of timber is therefore considerable. CLT, on the other hand, mixes boards of different strengths, and the risk of the weakest cross-sections coinciding in the same direction and layer is small. This is often referred to as the system effect.

When designing CLT components, the characteristic strength and stiffness of the constituent boards is sometimes used, rather than the values from the ETA. The system strength is particularly pronounced for the bending and tensile effect of CLT, where multiple parallel boards can interact. In calculations using the characteristic strength of the boards, CLT components are likely to have a somewhat higher characteristic strength, as it is not just one but several boards that are being bent or pulled at the same time. No strength classes have yet been developed for CLT, and so instead the bending and tensile strength can be increased with the help of a system effect factor, k_{sys} .

Different ETA's and handbooks may list different values for k_{sys} , from 0.9 up to 1.2. The factor is determined based on the number of boards in tension and on the extent of the samples, when determining the properties of the panel. Since it is hard to know at an early stage how many boards there are in a cross-section, k_{sys} can be determined as follows:

$$2.6 \quad k_{sys} = \min \left\{ \begin{array}{l} 1.15 \\ 1 + 0.1 \cdot b \end{array} \right.$$

where b is the effective width of the cross-section in m.

2.2 Material properties of CLT

CLT comprises at least three, and usually a maximum of seven, layers of boards, each layer perpendicular to the next, where the cross-section is usually symmetrical with an odd number of layers. This gives a component with high transverse stiffness and small moisture-related deformations. As a rule, the different layers of boards have the same thickness, but sometimes the inner layers may be thicker or thinner. The layers may also comprise two bonded boards in the same direction. The layers of boards are usually glued together, but other bonding systems also occur (nails, dowels), although these products are not called CLT. Some manufacturers glue the edges of the boards, and some make CLT with nine or more layers. CLT tends to be made from softwood, but there are manufacturers who use other wood species.

The maximum dimensions of the panels are usually around 3×16 m, but this varies depending on the manufacturer, and some can make even larger panels. The moisture content for the constituent material should be 8 – 14 % and it should be tailored to the intended area of use. The boards are sorted according to set strength classes and finger-jointed timber is used. If finger-jointed timber is not used, this should be considered when designing the components. The CLT manufacturers take account of this in their reported strength values.

The ultimate properties of the panels are determined by the properties of the constituent boards, but also by the system strength, as mentioned above. The boards used commonly have properties in accordance with BS-EN 338 or values reported and verified by the manufacturer. CLT panels are generally made from C24, with C14 or C16 used for some inner layers.

There are several theories and methods that are accurate and that can be used to calculate the properties of CLT.



7-layer CLT block made from spruce.



3-layer CLT panel made from birch.

Table 2.4 Material properties for strength-graded boards used to manufacture CLT

Board properties	C14	C16	C24	C30
Characteristic strength values (MPa)				
Bending strength $f_{m,k}$	14	16	24	30
Tensile strength along the grain $f_{t,0,k}$	7.2	8.5	14.5	19
Tensile strength perpendicular to the grain $f_{t,90,k}$	0.4	0.4	0.4	0.4
Compressive strength along the grain $f_{c,0,k}$	16	17	21	24
Compressive strength perpendicular to the grain $f_{c,90,k}$	2.0	2.2	2.5	2.7
Shear strength $f_{v,k}$	3.0	3.2	4.0	4.0
Stiffness values (MPa)				
Mean value of modulus of elasticity, along the grain $E_{m,0,mean}$	7,000	8,000	11,000	12,000
Fifth percentile value of modulus of elasticity, along the grain $E_{m,0,05}$	4,700	5,400	7,400	8,000
Mean value of modulus of elasticity, perpendicular to the grain $E_{m,90,mean}$	230	270	370	400
Mean value of the shear modulus G_{mean}	440	500	690	750
Density (kg/m³)				
Fifth percentile volume of density ρ_k	290	310	350	380
Mean density ρ_{mean}	350	370	420	460



Training facilities for dogs, Rosersberg, Sweden.

As part of the process of obtaining approval of CLT products, the manufacturers calculate the load-bearing capacity of the CLT panels for different cross-sections by determining the boards' properties via many samples and using calculation methods and stated boundary conditions.

A structural engineer designing CLT should therefore make use of the manufacturer's recommendations in the relevant ETA concerning material properties and methods, as far as possible.

According to BS-EN 16351, the mechanical properties of CLT can be determined using the following options:

- By determining and reporting the cross-sectional structure and relevant material properties of the constituent boards from which the properties of the CLT panel can be determined by calculation.
- By testing the CLT panel itself.

According to BS-EN 16351, as with other construction products, the CLT manufacturer must declare the properties of their products. If the method is used of declaring the CLT panel's properties based on standardised board properties according to BS-EN 338 together with a calculation method, the values obtained are as set out in *table 2.4, page 31*. See *Chapter 3, page 34*, for more information on panel properties.

This means that the stiffness and strength of a CLT panel are determined by the stiffness and strength of the layer. The values are determined for different axes, described as:

- x-axis – parallel with or along the main spanning direction of the CLT panel (usually along the grain of the top layer).
- y-axis – perpendicular to or across the main spanning direction of the CLT panel.
- z-axis – perpendicular to or across the x-y plane of the CLT panel.

The density of panels can be set at 1.0 times the density of the constituent boards in the serviceability and ultimate limit states. For panels in which different strengths are used in the different layers, the density for the lowest strength class should be used when calculating joints.

Load calculations usually use a density of between 450 and 550 kg/m³ for CLT panels.

Table 2.5 Density of CLT panels

Based on Swedish CLT production. Do not use for other sources of CLT.

Density		CLT panels with only C24 (kg/m ³)
Characteristic value	$\rho_{xlam,k}$	350
Mean value	$\rho_{xlam,mean}$	420



Training facilities for dogs, Rosersberg, Sweden.

Design of CLT structures

- 3.1 Out-of-plane behaviour 34
 - 3.1.1 Out-of-plane bending 34
 - 3.1.2 Out-of-plane shear 35
 - 3.1.3 Perpendicular-to-grain compression 37
 - 3.1.4 SLS deflection 37
- 3.2 In-plane behaviour 38
 - 3.2.1 In-plane compression 38
 - 3.2.2 In-plane tension 40
 - 3.2.3 In-plane bending 40
 - 3.2.4 In-plane shear 41
 - 3.2.5 SLS deflection 44
 - 3.2.6 Combined in-plane compression and out-of-plane bending, with second order effects 45
- 3.3 Examples 46
 - 3.3.1 One-way spanning CLT floor 46
 - 3.3.2 Cross-section properties for 5-layer non-symmetrical CLT panel 47
- 3.4 Design and analysis of CLT using software 49
- 3.5 Design tables 50

This chapter covers the design and analysis of CLT for in-plane and out-of-plane loads.

3.1 Out-of-plane behaviour

3.1.1 Out-of-plane bending

The bending stress at a distance y_i from the neutral axis parallel to the spanning direction of a CLT floor in bending can be calculated using beam theory:

$$3.1 \quad \sigma_{m,out,d} = \frac{M_{out,Ed} y_i E_i}{(EI)_{eff,out}}$$

where:

- $\sigma_{m,out,d}$ is the design bending stress due to out-of-plane moment.
- y_i is the distance from the neutral axis to the fibre we are checking.
- E_i is the Young's modulus at the fibre we are interested in.

For CLT planks where the outer boards have their grain in the direction of span, the maximum bending stress is given by:

$$3.2 \quad \sigma_{m,out,d} = \frac{M_{out,Ed} y_{out} E_0}{(EI)_{eff,out}}$$

where y_{out} is the distance from neutral axis to the outermost fibre.

This should then be checked against the parallel-to-grain design bending strength of the timber as below:

$$3.3 \quad \sigma_{m,out,d} \leq f_{m,d}$$

The effective flexural stiffness of the CLT out-of-plane for bending about an axis is calculated as follows:

$$3.4 \quad (EI)_{eff,out} = \sum (E_i I_{i,out} + E_i A_i e_i^2)$$

where:

- E_i is the Young's modulus of layer i .
- $I_{i,out}$ is the 2nd moment of area of layer i about its own axis.
- A_i is the area of layer i .
- e_i is the distance of the neutral axis of layer i from the neutral axis of the CLT section about which there is a bending moment. See figure 3.2, page 35.

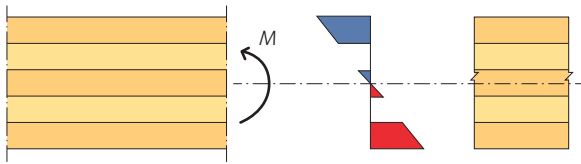

Figure 3.1 Bending stress distribution

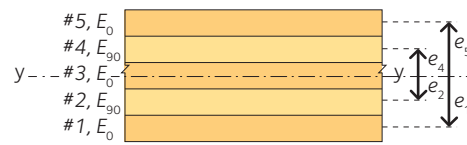

Figure 3.2 $EI_{\text{eff,out}}$ calculation

Since the modular ratio of parallel-to-grain Young's modulus, to perpendicular-to-grain Young's modulus (E_0/E_{90}) = 33 and $\sigma = E\varepsilon$ and also because of the gaps between boards, the I value of CLT out-of-plane can be calculated considering only the parallel-to-grain layers of CLT using the parallel axis theorem, see figure 3.1 and 3.2. Hence:

$$I_{\text{out}} = \sum (I_{\text{II},i,\text{out}} + A_{\text{II},i} e_{\text{II},i}^2)$$

Hence, assuming all layers have the same timber grade:

$$(EI)_{\text{eff,out}} = E_0 I_{\text{out}}$$

This then simplifies the equation for design bending stress at the outermost fibre (where outermost fibres are parallel to span) to:

$$\sigma_{\text{m,out,d}} = \frac{M_{\text{out,Ed}} y_{\text{out}}}{I_{\text{out}}}$$

In the above y_{out} is the distance from the neutral axis to the outermost fibre parallel to the spanning direction.

Hence, the elastic section modulus for CLT may be defined as:

$$W_{\text{out}} = \frac{(EI)_{\text{eff,out}}}{E_0 y_{\text{out}}}$$

where all layers have the same grade material this becomes:

$$W_{\text{out}} = \frac{I_{\text{out}}}{y_{\text{out}}}$$

Hence, the peak bending stress is given by:

$$\sigma_{\text{m,out,d}} = \frac{M_{\text{out,Ed}}}{W_{\text{out}}}$$

3.1.2 Out-of-plane shear

Looking at figure 3.3, it can be seen that the shear stress through a rectangular CLT cross-section is not parabolic. The reason for this is the composite nature of CLT due to the cross-grain layers. Since the parallel-to-grain shear modulus G_0 is ten times the rolling shear modulus G_{90} , the shear stress increase across the perpendicular to grain layers is minimal, leading to a stepped parabolic shear stress distribution as shown in figure 3.3.

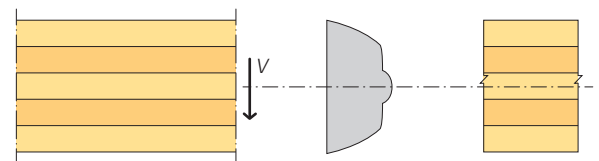

Figure 3.3 Shear stress distribution



Trafalgar Place apartments, London, England.

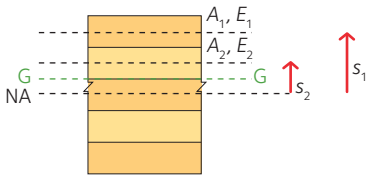

Figure 3.4 Calculation of the 'first moment of area stiffness'

The shear stress distribution through a CLT section can be calculated using the standard expression shown below:

$$3.11 \quad \tau(s)_{\text{out,d}} = \frac{V_{\text{out,Ed}} Q[s(E(s))]_{\text{out}}}{(EI)_{\text{eff,out}} b}$$

The 'first moment of area stiffness' can be calculated as:

$$3.12 \quad Q[s(E(s))]_{\text{out}} = \sum E_i A_i s_i$$

where s_i is the distance from the neutral axis to the centroid of an area (potentially one of many) above the point we are calculating the shear stress for. For example, if we are interested in the shear stress at axis GG in figure 3.4 then the 'first moment of area stiffness' of the section is:

$$3.13 \quad Q[s(E(g))]_{\text{out}} = E_1 A_1 s_1 + E_2 A_2 s_2$$

In general, the first moment of area stiffness would be calculated at the neutral axis, as this is where the shear stress would be greatest; the example above is provided to illustrate the principle.

For shear due to bending about a given axis, in theory three checks should be made:

1. Maximum shear stress in the most highly stressed parallel-to-span layer, compared to the parallel-to-grain shear strength.
2. Maximum shear stress in the most highly stressed perpendicular-to-span layers, compared to the rolling shear strength, refer to figure 3.6, page 37. For softwood CLT panels the rolling shear strength is about 1 N/mm² (refer to ETAs for exact values).
3. A shear check of the net section parallel to the direction of span, excluding layers with grain perpendicular to the span direction. This is because edge-gluing is not normally carried out, and even where it is, shrinkage cracking will create gaps between the boards.

It can be shown that the shear stress distribution in a CLT panel tends towards a parabola as the number of layers in the CLT panel increases.

Hence in most cases one can replace the first two checks with a single conservative shear strength check by checking the absolute maximum shear stress in the CLT section (which will be at the neutral axis) against the rolling shear strength:

$$3.14 \quad \tau_{\text{out,d,gross}} = \frac{1.5V_{\text{Ed,out}}}{A_{\text{gross,out,V}}} \leq f_{v,90,d}$$

where $A_{\text{gross,out,V}}$ is as defined below.

Check 3 is as follows. However, check three rarely governs and can generally be neglected.

$$3.15 \quad \tau_{\text{out,d,net}} = \frac{1.5V_{\text{Ed,out}}}{A_{\text{net}}} \leq f_{v,0,d}$$

where A_{net} is the total area with grain parallel to the direction of span.

The gross section $A_{\text{gross,out,V}}$ to be used in the above is as follows:

$$A_{y,\text{gross,out,V}} = bt_{\text{CLT,yy}}$$

for shear due to bending about the stronger (i.e. the y) axis, refer to figure 3.5.

$$A_{x,\text{gross,out,V}} = bt_{\text{CLT,xx}}$$

for shear due to bending about the weaker (x) axis, refer to figure 3.5.

Note: For verification of shear out-of-plane due to moment about the weak axis, the outer layers (which will be perpendicular to the span direction) are ignored.

Note: CLT should normally be designed for out-of-plane behaviour, assuming it is one way spanning about the strong axis, since half lap joints between panels cannot transfer any significant shear or bending out-of-plane. However, for checking SLS vibration, half lap joints along the long edges of the CLT panel can be assumed to be fixed if the grain directions of the outer spanning layers are parallel to the lapped edge.

Asymmetric Sections

Asymmetric CLT sections should be assessed in the same way as symmetric sections, the only difference being that the neutral axis is no longer guaranteed to be in the centre of the section. Hence the location of the neutral axis (Z_{NA}) measured from the bottom of the section must first be calculated prior to any further calculations being carried out.

$$Z_{\text{NA}} = \frac{\sum(E_i A_i O_i)}{\sum(E_i A_i)}$$

O_i is the distance from the bottom of the section to the centroid of lamella i.

The distance from the neutral axis to the centroid of a lamella, e , is then given by:

$$e_i = |Z_{\text{NA}} - O_i|$$

3.1.3 Perpendicular-to-grain compression

Where perpendicular-to-grain compression occurs, such as in platform frame CLT construction, the following check should be carried out:

$$\sigma_{\text{c,out,d}} \leq k_{\text{c,90}} f_{\text{c,90,d}}$$

The factor $k_{\text{c,90}}$ accounts for load spread and should be taken from the manufacturer's European technical approval (ETA). It can be conservatively assumed to have a value of 1.

3.1.4 SLS deflection

When calculating deflection of timber members, the shear deflection should also be considered due to the low shear modulus of timber, hence the total deflection will be the sum of both bending and shear deflection. This is particularly important for CLT due to the shear flexibility of the cross-grain layers.

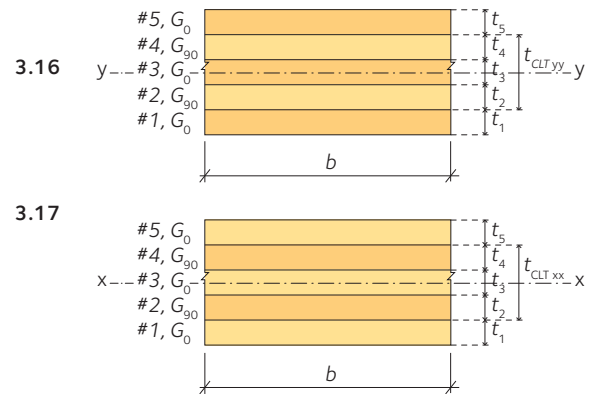

Figure 3.5 Gross area calculation for verification of shear stresses

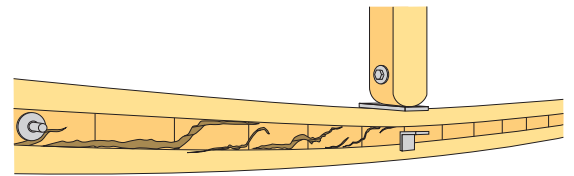

Figure 3.6 Rolling shear failure due to out-of-plane loading

3.18

3.19

3.20

Bending deflection is dependent on the $(EI)_{\text{eff}}$ calculated using the parallel axis theorem:

$$3.21 \quad (EI)_{\text{eff,out}} = \sum (E_i I_{i,\text{out}} + E_i A_i e_i^2)$$

Since the orthogonal layers are much less stiff than the parallel-to-span layers, they can be neglected in the above calculation.

The out-of-plane shear stiffness of one way spanning CLT takes the form below, which is from standard beam theory:

$$3.22 \quad K_{\text{shear,out}} = \frac{C\kappa(GA)_{\text{eff,out}}}{L_{\text{Span}}}$$

Table 3.1 Shear correction factor for out-of-plane loading

Layup	κ for shear due to moment about the strong axis	κ for shear due to moment about the weak axis
3 Layers	0.16	0.7
5 layers and above	0.2	0.15

where the usual factor C accounts for the distribution of shear force along the beam. The factor κ is a factor that accounts for the effect of non-uniform distribution of elastic shear stress through the section. For a non-composite rectangular section (as opposed to CLT which is composite) κ would be equal to $5/6$. For currently available CLT products, typical values of κ are given in *table 3.1*.

For CLT the effective GA should be calculated using the equation below:

$$3.23 \quad (GA)_{\text{eff,out}} = \sum (G_i A_i)$$

$GA_{\text{eff,out}}$ may be approximated to:

$$3.24 \quad (GA)_{\text{eff,out}} = G_0 A_{\text{net}}$$

where A_{net} is the area with grain parallel to spanning direction.

3.2 In-plane behaviour

3.2.1 In-plane compression

Given that $(E_o/E_{90}) = 33$, an in-plane axial force N is resisted almost entirely by the layers with grain parallel to the direction of force application. Hence, the net section area A_{net} of the parallel-to-force layers are used for calculations.

An in-plane axial compressive force on CLT panels can lead to two types of failure:

1. Crushing failure of the net section.
2. Buckling failure of the member.

Crushing

The design axial force should be checked against the strength of the parallel-to-force layers. Hence:

$$3.25 \quad A_{\text{net}} = L_{\text{plan}} \sum t_{\parallel}$$

where:

$\sum t_{\parallel}$ is the total thickness of layers with grain parallel to the direction of loading.

L_{plan} is the length of the member in the direction perpendicular to direction of loading.

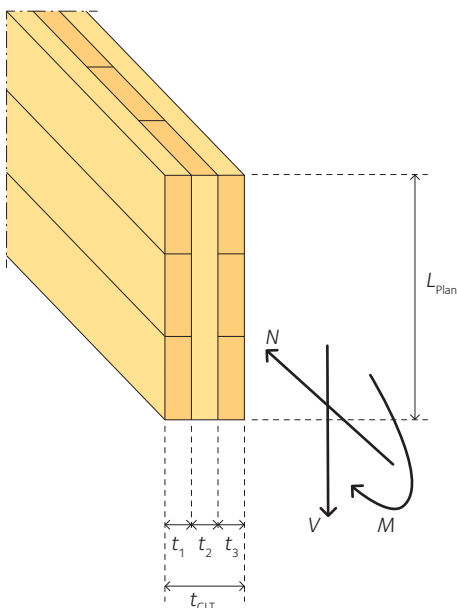

Figure 3.7 In-plane loading of CLT

The compressive axial stress on the net section is then checked against the design compressive strength of the CLT.

$$\sigma_{c,in,net,d} = \frac{N_{in,Ed}}{A_{net}} \leq f_{c,0,d} \quad 3.26$$

Buckling – k_c method

For slender walls it is necessary to check buckling of the CLT between lateral supports (e.g. axial buckling of a core wall between two floors). Current best practice is to carry out a conservative check considering a metre length of wall as a column. Here the following check must be carried out:

$$\sigma_{c,in,net,d} \leq k_c f_{c,0,d} \quad 3.27$$

where:

$$k_c = \min \left\{ 1, \frac{1}{\beta + \sqrt{\beta^2 - \lambda_{rel}^2}} \right\}$$

$$\beta = 0.5 \left(1 + \alpha_{CLT} (\lambda_{rel} - 0.3) + \lambda_{rel}^2 \right)$$

$$\alpha_{CLT} = 0.1$$

$$\lambda_{rel} = \sqrt{\frac{A_{net} f_{c,0,k}}{N_{cr}}}$$

$$N_{cr} = \frac{(EI)_{eff,0.05,out} \pi^2}{l_{ef}^2 + \frac{(EI)_{eff,0.05,out}}{\kappa (GA) l_{ef,0.05,out}^2}}$$

l_{ef} is the effective buckling length of the wall (this is generally the height of the wall between floors restraints).

In most cases the effect of shear flexibility (taken into account in the right hand term in the denominator for N_{cr}) has negligible effect.

Note: In the calculation of N_{cr} the characteristic Young's modulus should be used, as the buckling check is a ULS check.

It should be noted that the k_c method is based on the non-linear method. The factor α_{CLT} is given as 0.1 in most ETAs and corresponds to an initial imperfection of approximately height/1000. When no safety factors are applied at a utilisation of unity, both methods will give the same results. When safety factors are applied at utilisation below 1, the k_c method will give a more conservative answer.

It is important to note that it is the non-linear method that gives the more correct answer in line with the physics of the problem.

Buckling – Non-linear method

$$3.28 \quad \frac{N_{\text{in,Ed}}}{N_{\text{Rd}}} + \frac{M_{\text{Ed}}^{\text{NL}}}{M_{\text{Rd}}} \leq 1$$

$$3.29 \quad N_{\text{Rd}} = A_{\text{net}} f_{\text{c},0,\text{d}}$$

$$3.30 \quad M_{\text{Ed}}^{\text{NL}} = \frac{1}{\left(1 - \frac{N_{\text{Ed}}}{N_{\text{cr}}}\right)} (N_{\text{Ed}} \delta_0)$$

where δ_0 is the initial bow imperfection of the CLT (assuming a value of $l/1000$, where l is the height of the wall between restraints, will give the same answer as the k_c method at a utilisation of unity when $k_{\text{mod}} = 1$ and $\gamma_M = 1$).

Creep buckling

At scheme stage it is acceptable to check permanent and long-term loadcases using the characteristic long-term E value, whilst checking all other loadcases with the short-term E value. This may in some cases be marginally unconservative.

3.2.2 In-plane tension

Again, in-plane tension of CLT should be verified considering only the parallel-to-force net area.

$$3.31 \quad \sigma_{\text{t,in,net,d}} = \frac{N_{\text{in,Ed}}}{A_{\text{net}}} \leq f_{\text{t},0,\text{d}}$$

where A_{net} is the area with grain running parallel to direction of loading.

3.2.3 In-plane bending

As with out-of-plane bending, the in-plane bending behaviour of CLT is analysed considering only the parallel-to-span layers of the CLT. Hence the in-plane I value of CLT is calculated as follows, where L is defined in figure 3.8, page 41.

$$3.32 \quad I_{\text{net,in}} = \frac{(\Sigma t_{\parallel}) L^3}{12}$$

where Σt_{\parallel} is the total thickness of layers with grain running parallel to the direction of load.

However, one key difference from glulam is the fact that logically the in-plane bending stresses should just be treated as in-plane compression and tension. This would imply that the bending stress calculated as given below should be checked against the compressive and tensile capacity of the timber. However, guidance on this is somewhat unclear, and some ETAs suggest that in-plane bending stresses (calculated as below) should be checked against bending strengths.

$$3.33 \quad \sigma_{\text{m,in,net,d}} = \frac{M_{\text{in,Ed}} L}{2 I_{\text{net,in}}}$$

In-plane bending often occurs in walls. Where the wall is slender and buckling needs to be considered then the most highly stressed metre length of wall should be checked, refer to figure 3.8. Usually it will be necessary to consider the peak compressive stress due to bending combined with applied compressive stress due to vertical loading.

3.2.4 In-plane shear

The in-plane shear behaviour of CLT is highly complex. This should be checked at the detailed design stage according to the manufacturer's ETA. At scheme design stage the methods in this manual (based on first principles and the latest research) can be used. The methods given here for calculating torsional shear are from the work of Boggensperger et al. This is because CLT boards in a given layer are often not edge-glued. This allows for differential drying shrinkage of adjacent layers. Even when edges are glued, shrinkage leads to splitting of the CLT planks; the spacing between splits is obviously difficult to predict, but the overall effect is similar to if the planks had not been edge-glued. The overall effect of this gluing regime is illustrated in figure 3.9.

Hence the in-plane shearing of CLT gives rise to the following main effects, refer to figure 3.10:

1. Shearing of the gross section at crossing points.
2. Torsion at the crossing areas across the glued interfaces, refer to figure 3.11, page 42.
3. Shearing of the net section at gaps between the crosswise planks.
4. Transverse shearing through the cross-section due to the transfer of in-plane bending stresses from longitudinal (parallel-to-span of in-plane bending) to orthogonal boards.

Whilst this behaviour may initially seem very complex, it can be understood and visualised by thinking of the CLT as a moment frame with very stocky beams and columns. Whilst frames are normally 2D, our idealised CLT frame is 3D due to the nature of the crossing points. So it helps to think of the moment transfer between 'columns' (vertical boards) and 'beams' (horizontal boards) as being through very short beams through the thickness of the CLT plate in torsion as shown below. Given the extremely stocky nature of beams in this analogous 'frame', bending effects in the areas between crossing points can be neglected.

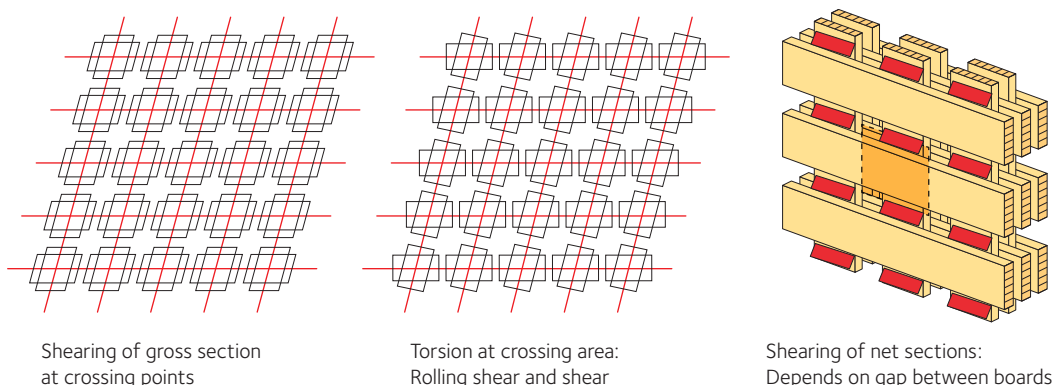

Figure 3.10 Deformation modes due to in-plane shear

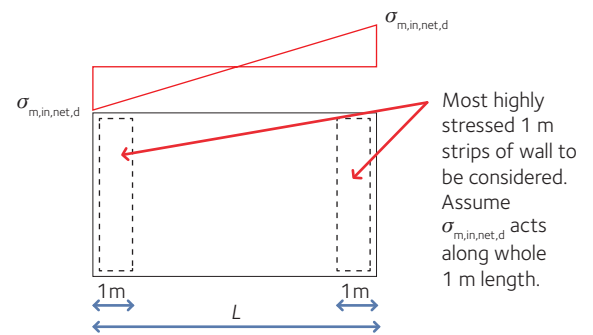

Figure 3.8 In-plane bending calculation

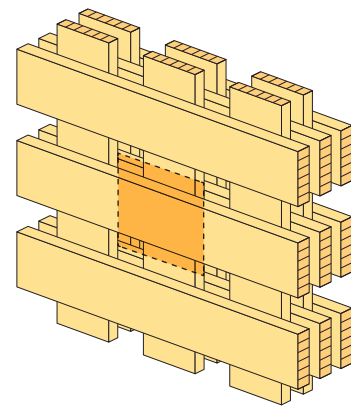

Figure 3.9 Exaggerated image of gaps between boards (or the effect of splits between edge glued boards)

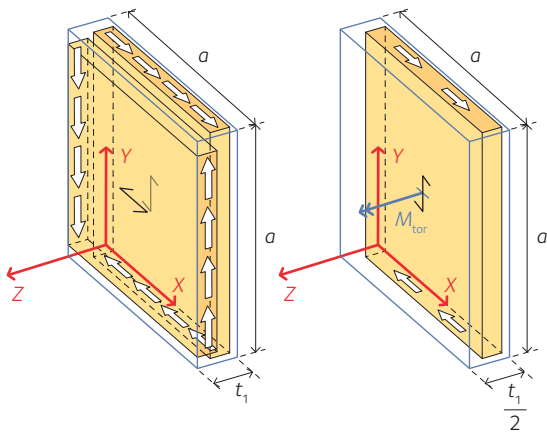

Figure 3.11 Torsion at crossing areas due to in-plane shear in a representative sub-volume element ('RVSE')
The diagram on the right shows the forces on the half system.

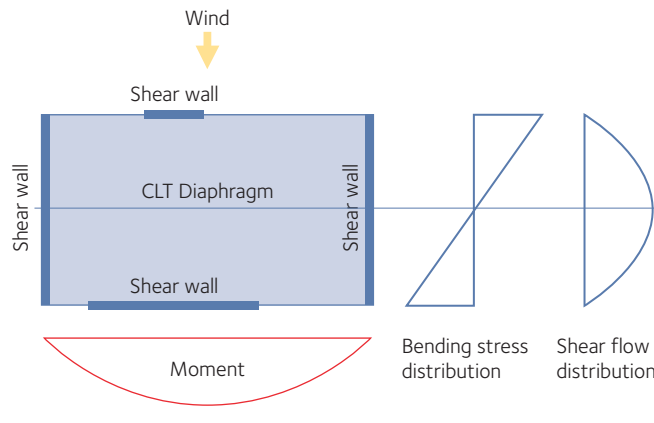

Figure 3.12 Global stress distribution in a CLT diaphragm

For ULS strength verification it is necessary to check the net shear stress in the net area, and torsion at the crossing areas. For diaphragms through thickness shear (i.e. effect 4 above) is usually negligible. The starting point for verification of in-plane shear strength of an element is to obtain the shear force on the element as a shear force per unit length.

If we had a timber diaphragm between two shear walls (as shown in figure 3.12) with wind applied to the long face, we can think of the timber diaphragm as working as a deep beam. Here the maximum shear flow per unit length in the diaphragm will be:

$$3.34 \quad \overline{V}_{in,Ed} = \frac{1.5V_{in,Ed}}{L_{plan}}$$

L_{plan} in the equation above is as defined in figure 3.7, page 38. Since the diaphragm will have to be designed to remain elastic, due to the brittle nature of timber, the approximate shear force per metre (i.e. the shear flow) will have a parabolic distribution in order to be in equilibrium with an elastic in-plane bending stress distribution in the diaphragm.

Check 1: Shearing of the net section

$$3.35 \quad \tau_{net,max,inplane,Ed} = \frac{1.5\overline{V}_{in,Ed}}{t_{net,min}} \leq f_{v,0,d}$$

Note that the lesser net section is used in the calculation of the shear stress, even if the CLT plank is orientated such that the greater net section is orientated in the in-plane spanning direction of the diaphragm. The reason for this is that for equilibrium the complementary shear flows must be equal. Hence for equilibrium, the shear stress in the lesser of the net areas must be greater as shown in figure 3.13.

The factor 1.5 in the equation above for calculating $\tau_{net,max,inplane}$ arises from the fact that in between crossing points, the net sections must have parabolic shear stress distributions.

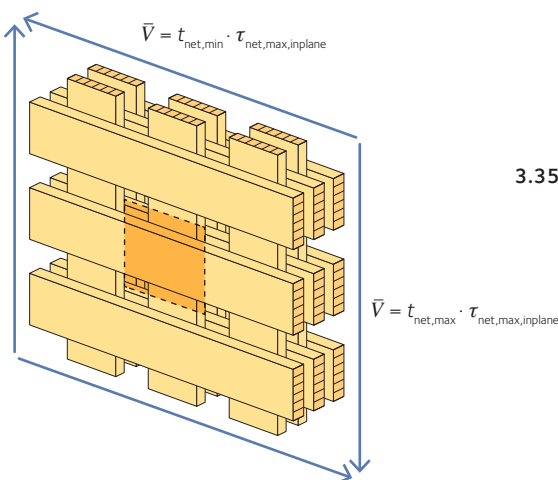

Figure 3.13 Complementary shear flows in CLT

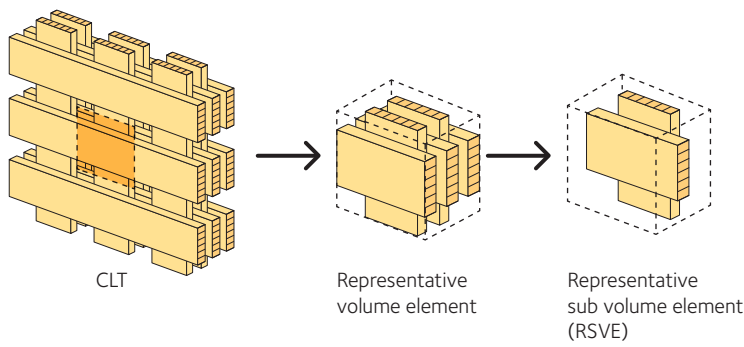

Figure 3.14 Representative sub volume elements

Check 2: Torsional shearing at the crossing points

Torsional shear stress is calculated as follows:

Given that the shear force is per metre length, the shearing effects at each crossing point must be the same. Hence we only need to check the torsional shear at the location where shear flow is the highest. We can now look at a representative volume element. These volume elements are made up of repeating “representative sub-volume elements” (RSVE’s) through the thickness of the panel, refer to figure 3.14. Each RSVE is made up of two boards on either side of a crossing point, both with half-layer thicknesses. Hence the thickness of the RSVE is the sum of the two half-thicknesses. Given that the RSVEs are an idealisation of the crossing points, there will be one fewer RSVE than there are layers in the CLT plank.

The thickness of the RSVEs can be obtained from table 3.2.

The next step is to work out how much shear force is being resisted by each RSVE. The shear force per unit length on each RSVE is determined by comparing effective stiffnesses of each RSVE.

$$\overline{V_{ed,RSVE(i)}} = \overline{V_{in,Ed}} \frac{t_i^*}{\sum t_i^*} \quad 3.36$$

The shear stress in the RSVE is then given by:

$$\tau_{i,Ed}^* = \frac{\overline{V_{ed,RSVE(i)}}}{t_i^*} \quad 3.37$$

The torsional moment across the RSVE is given by:

$$M_{T,i} = \text{Force} \times \text{Lever arm} \quad 3.38$$

$$M_{T,i} = (\tau_i^* t_i^* a) \times a \quad 3.39$$

where a is the board width.

Making the simplifying assumption (but one which is accounted for by experimental calibration) that torsional stress through a beam with a square section for an isotropic material is given by:

$$\tau_T = \frac{M_T}{I_p} \times \frac{a}{2} \quad 3.40$$

Where the polar moment of area is given by:

$$I_p = \frac{a^4}{6} \quad 3.41$$

Table 3.2 Idealised thickness of RSVEs

RSVE	Idealised thickness
Internal/External	$t_i^* = \min(2t_{int}, t_{ext})$
Internal/Internal	$t_i^* = \min(t_{int1}, t_{int2})$

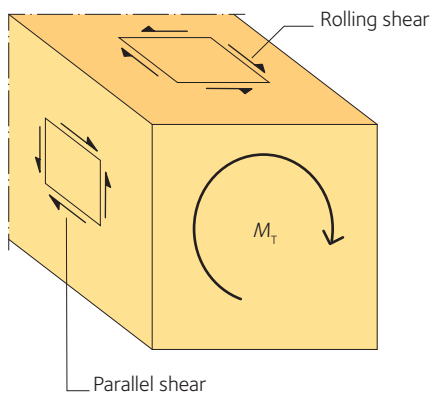

Figure 3.15 Illustration of shearing through crossing areas due to torsion at crossing points

The next step is to calculate the torsional ‘stress’ in the crossing area and check it against the torsional shear strength of the crossing area:

$$3.42 \quad \tau_{T,i,Ed}^* = \frac{3\tau_i t_i^*}{a} \leq f_{T,d}$$

Due to the orthogonal nature of CLT, the torsional stress through the crossing area is highly complex. This is because the torsional moment is resisted by rolling shear and parallel-to-grain shear at different points in the section, as shown in *figure 3.15*.

The above equation deals with this problem by treating the timber cross-section at crossing points as isotropic. The idealised ‘isotropic torsional shear stress’ is then checked against a torsional shear strength (generally for softwood a characteristic value of 2.5 N/mm²) that has been determined from physical testing. Thereby, the complex nature of torsional shear through a non-homogenous material is accounted for.

3.2.5 SLS deflection

The in-plane bending behaviour of CLT is dependent on $E_o I_{o,net}$ where $I_{o,net}$ is calculated considering only the parallel-to-span layers of the CLT.

Unlike with concrete shear walls, the effects of in-plane shear deflection must also be considered. This is because the in-plane shear stiffness of CLT is low and also due to the fact that most CLT shear walls tend to be much stockier than the concrete shear walls needed to stabilise a similar building.

The in-plane G value must take into account the combined effects of the various mechanisms of in-plane shear (excluding transverse shear, which is a local effect). Thinking of the three mechanisms as the equivalent of three sets of springs in series, the in-plane gross G value can be expressed as follows:

$$3.43 \quad G_{in-plane} = \frac{1}{\frac{1}{G_{torsion}} + \frac{1}{G_{gross}} + \frac{1}{G_{net}}}$$

The value of $G_{in-plane}$ applied to the total area of the section depends on the board width, board thickness, spacing between boards and layup. Given the analytical complexity of calculating $G_{in-plane}$, coupled with the practical uncertainty of the gaps or splits between boards, $G_{in-plane}$ is obtained from experimental testing. $G_{in-plane}$ is normally given in the CLT ETA by the manufacturer. The value of $G_{in-plane}$ from the limited amount of testing to date suggests that its values are approximately 0.3 – 0.65 G_o .

The in-plane shear stiffness of a panel is given by:

$$3.44 \quad G_{in-plane} A_{tot}$$

Note that since $G_{in-plane}$ is determined from testing, no shear correction factor (*refer to section 3.1.4, page 37*) need be applied.

It should be noted that where multi-panel structures are loaded in-plane, most of the flexibility of the system is likely to be due to the connections.



Cambridge Heath apartments, London, England.

3.2.6 Combined in-plane compression and out-of-plane bending, with second order effects

This loadcase could occur where a wall is loaded eccentrically at the top, or where an external wall is subjected to face wind and axial load. The following check should be made for the peak compression on one side of the wall. The checks below should be carried out per metre of the most highly stressed parts of the wall.

$$\frac{\sigma_{c,in,net,d}}{k_c f_{c,0,d}} + \left(\frac{1 + \omega \frac{N_{in,Ed,1}}{N_{cr,1}}}{1 - \frac{N_{in,Ed,1}}{N_{cr,1}}} \right) \frac{\sigma_{m,out,Ed}}{f_{m,d}} \leq 1 \quad 3.45$$

where:

- $N_{in,Ed,1}$ is the axial force in the most highly stressed metre of wall.
- $N_{cr,1}$ is the Euler critical load of a plane metre length of wall.

The Dischinger factor ω (which is the Fourier coefficient of the first term of the Fourier series idealising each moment shape) is calculated from *table 3.3*:

Table 3.3 Dischinger factors

0.273	0.032	-0.189	-0.090	-0.420	-0.650	-0.210

3.3 Examples

3.3.1 One-way spanning CLT floor

Span	5 m
Layup	20/40/20/40/20
Depth	140 mm
Live load	1.5 kN/m ²
Super-imposed dead load	0.85 kN/m ²
Density	420 kg/m ³
Dead load	$0.14 \times 420 \times (9.8/1000) = 0.576$ kN/m per m

The following calculations are carried out per metre width of floor.

$$w = 1.35(DL + SDL) + 1.5LL = 1.35(0.576 + 0.85) + 1.5(1.5) = 4.17 \text{ kN/m}$$

Design moment:

$$M_{Ed} = \frac{4.17 \times 5^2}{8} = 13 \text{ kNm}$$

Design shear force:

$$V_{Ed} = \frac{4.17 \times 5}{2} = 10.4 \text{ kN}$$

Calculation of I effective:

Assume perpendicular layers do not contribute due to gaps between the narrow faces:

$$I_{\text{eff,out}} = \sum (I_{i,\text{out}} + A_i e_i^2)$$

$$= (I_{1,\text{out}} + A_1 e_1^2) + (I_{3,\text{out}} + A_3 e_3^2) + (I_{5,\text{out}} + A_5 e_5^2)$$

$$I_{\text{eff,out}} = \left(\frac{1000 \times 20^3}{12} + (1000 \times 20) \times 60^2 \right) + \left(\frac{1000 \times 20^3}{12} + (1000 \times 20) \times 0^2 \right) + \left(\frac{1000 \times 20^3}{12} + (1000 \times 20) \times 60^2 \right)$$

$$I_{\text{eff,out}} = 145 \times 10^6 \text{ mm}^2$$

Calculation of peak bending stress:

$$\sigma_m = \frac{My}{I_{\text{eff,out}}} = \frac{13 \times 10^6}{145 \times 10^6} \frac{140}{2} = 6.3 \text{ N/mm}^2$$

Calculation of peak shear stress:

$$\tau(s)_{\text{out,d}} = \frac{V_{\text{out,Ed}} Q \left[s(E(s)) \right]_{\text{out}}}{(EI)_{\text{eff,out}} b}$$

where:

$$\begin{aligned} Q\left[s(E(s))\right]_{\text{out}} &= \sum E_i A_i s_i = (E_1 A_1 s_1) + (E_2 A_2 s_2) + 0.5(E_3 A_3 s_3) \\ &= (11000 \times \{1000 \times 20\} \times 60) + (0 \times \{1000 \times 40\} \times 30) + (11000 \times \{1000 \times 20\} \times 5) \\ &= 1.43 \times 10^{10} \text{ Nmm} \end{aligned}$$

$$\tau(s)_{\text{out,d}} = \tau(s)_{\text{out,d}} = \frac{10.4 \times 10^3 \times 1.43 \times 10^{10}}{11000 \times 145 \times 10^6 \times 1000} = 0.09 \text{ N/mm}^2$$

Calculation of deflection:

$$w_{\text{SLS}} = DL + SDL + LL = 0.576 + 0.85 + 1.5 = 2.93 \text{ kN/m}$$

$$\Delta_{\text{Tot}} = \Delta_{\text{Bending}} + \Delta_{\text{Shear}}$$

$$= \frac{5wl^4}{384(EI)_{\text{eff,out}}} + \frac{wl^2}{8\kappa(GA)_{\text{eff,out}}}$$

where:

$$\begin{aligned} (GA)_{\text{eff,out}} &= \sum (G_i A_i) = (G_1 A_1) + (G_2 A_2) + (G_3 A_3) + (G_4 A_4) + (G_5 A_5) \\ &= (650 \{1000 \times 20\}) + (65 \{1000 \times 40\}) + (650 \{1000 \times 20\}) + (65 \{1000 \times 40\}) + (650 \{1000 \times 20\}) \\ &= 4.42 \times 10^7 \end{aligned}$$

$$\Delta_{\text{Tot}} = \frac{5 \times 2.93 \times 5000^4}{384 \times 11000 \times 146 \times 10^6} + \frac{2.93 \times 5000^2}{8 \times 0.2 \times 4.42 \times 10^7} = 15.9 \text{ mm}$$

3.3.2 Cross-section properties for 5-layer non-symmetrical CLT panel

This applies to the fire condition.

The CLT panel is made up of five layers with a total thickness $h_{\text{CLT}} = 160 \text{ mm}$. The calculation is based on a CLT panel with a width $b = 1.0 \text{ m}$.

Layup thicknesses are 20/30/40/30/40 for layers 1 – 5 respectively.

Material values:

Layers 1 and 5 are C24; layers 2,3 and 4 are C16

$E_0 = 11,000 \text{ MPa}$ for timber in strength class C24

$E_0 = 8,000 \text{ MPa}$ for C16

$E_{90} = 0 \text{ MPa}$, $G_{090} = 650 \text{ MPa}$ and $G_{9090} = 50 \text{ MPa}$.

Calculation of centres of gravity, O_i calculated as below:

$$O_5 = 160 - \frac{40}{2} = 140 \text{ mm}$$

$$O_3 = 160 - 40 - 30 - \frac{40}{2} = 70 \text{ mm}$$

$$O_1 = 160 - 40 - 30 - 40 - 30 - \frac{20}{2} = 10 \text{ mm}$$

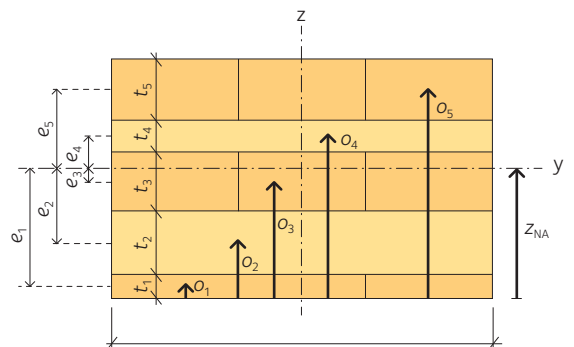

Figure 3.16 Asymmetric section used for the example

Then calculate the distance to the neutral axis as defined in figure 3.16, page 47:

$$Z_{NA} = \frac{\sum(E_i A_i O_i)}{\sum(E_i A_i)} = \frac{[11000(1000 \times 40)140] + [8000(1000 \times 40)70] + [11000(1000 \times 20)10]}{[11000(1000 \times 40)] + [8000(1000 \times 40)] + [11000(1000 \times 20)]}$$

$$= \frac{8.62 \times 10^{10}}{9.8 \times 10^8} = 88 \text{ mm}$$

In the above calculation, perpendicular-to-span layers 2 and 4 have been neglected assuming that there are gaps between the boards.

Noting that:

$$e_i = |Z_{NA} - O_i|$$

$$e_5 = |88 - 140| = 52 \text{ mm}$$

$$e_3 = |88 - 70| = 18 \text{ mm}$$

$$e_1 = |88 - 10| = 78 \text{ mm}$$

$$(EI)_{\text{eff,out}} = \sum(E_i I_{i,\text{out}} + E_i A_i e_i^2)$$

$$= E_5 (I_{5,\text{out}} + A_5 e_5^2) + E_3 (I_{3,\text{out}} + A_3 e_3^2) + E_1 (I_{1,\text{out}} + A_1 e_1^2)$$

$$= 11000 \left(\frac{1000 \times 40^3}{12} + (1000 \times 40) \times 52^2 \right) + 8000 \left(\frac{1000 \times 40^3}{12} + (1000 \times 40) \times 18^2 \right) + 11000 \left(\frac{1000 \times 20^3}{12} + (1000 \times 20) \times 78^2 \right)$$

$$= 1.25 \times 10^{12} + 1.46 \times 10^{11} + 1.35 \times 10^{12} = 2.75 \times 10^{12} \text{ Nmm}^2$$

Given that we have materials of two different grades, the bending stress should be checked at:

- The C16 fibre furthest from the neutral axis.
- The C24 fibre furthest from the neutral axis.

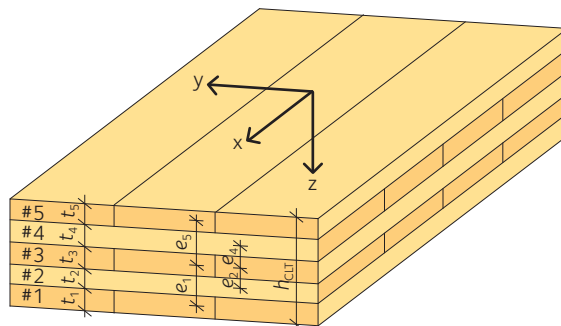

Figure 3.17 Definition of directions and measurements.

3.4 Design and analysis of CLT using software

A CLT panel can be modelled as 2D shell elements. The designer should bear in mind the following:

- CLT floor systems are generally one-way spanning (since half-lap joints along the long edges parallel to the main direction of span can generally only take in-plane forces).
- Unlike in steel and concrete structures, in CLT (and more generally timber) structures, most of the flexibility is due to flexibility and slip of the connections.
 - This can effect global SLS deflections.
 - Where loadpaths are indeterminate, it may also lead to uncertainty of forces in elements. Such situations require special treatment. Unlike steel and well-designed concrete structures, in a timber structure with generally brittle behaviour, loads are not able to redistribute to the loadpaths assumed in the model. In such situations a sensitivity analysis to investigate the effect of variable connection stiffness on loadpath should be carried out.
- Whilst most software allows for orthotropy to be modelled (i.e. different E and G values in different directions), it does not accurately model the stress distribution within the section due to the composite nature of CLT. Hence forces and moments should be obtained from the model (rather than stresses). Internal stresses in the CLT should then be calculated from these forces and moments using the methods described in this handbook.
- When modelling CLT in software, it is important to ensure that stiffness is correctly modelled for the directions being considered:

For elements that are loaded out-of-plane (e.g. floors) the following equations should apply:

For moment about the Y axis:

$$E_{x,\text{software}} = \frac{\overline{[EI]_{y,\text{eff,out}}}}{I_{\text{software}}}$$

$$G_{xz,\text{software}} = \frac{k\overline{[GA]_{xz,\text{eff}}}}{0.83A_{\text{software}}}$$

For moment about the X axis:

$$E_{y,\text{software}} = \frac{\overline{[EI]_{x,\text{eff,out}}}}{I_{\text{software}}}$$

$$G_{yz,\text{software}} = \frac{k\overline{[GA]_{yz,\text{eff}}}}{0.83A_{\text{software}}}$$

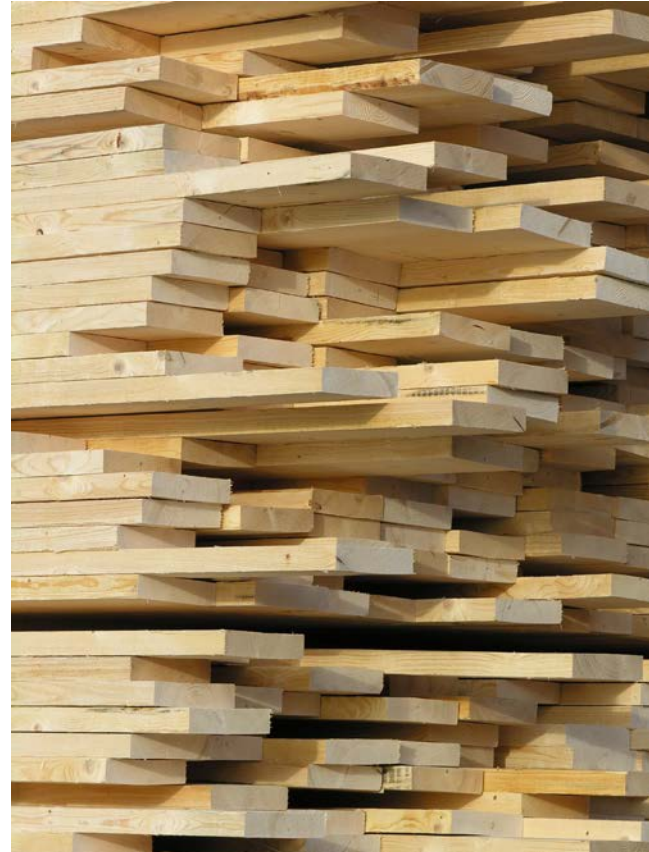

Boards to be used for CLT panels.

where:

- $E_{x,software}$ is the Young's modulus per m in the x direction that should be input into the model.
- $E_{y,software}$ is the Young's modulus per m in the y direction that should be input into the model.
- $\overline{[EI]}_{y,eff,out}$ is the effective stiffness per m of the CLT about the y axis.
- $\overline{[EI]}_{x,eff,out}$ is the effective stiffness per m of the CLT about the x axis.
- $I_{software}$ is the 2nd moment of area per m of element in the software package.
- $A_{software}$ is the area per m of element in the software package.

For elements that are loaded in-plane (e.g. walls or floors) the following equations should apply:

$$E_{x,software} = \frac{\overline{A_{x,net}}}{A_{software}} E_0$$

$$E_{y,software} = \frac{\overline{A_{y,net}}}{A_{software}} E_0$$

where:

- $A_{software}$ is the area per m of the element modelled in the software.
- $\overline{A_{x,net}}$ is the area per m of the CLT panel with grain parallel to the x axis.
- $\overline{A_{y,net}}$ is the area per m of the CLT panel with grain parallel to the y axis.

3.5 Design tables

The following tables give:

- $A_{x,net}$ and $A_{y,net}$ for calculation of in-plane stresses.
- $I_{y,out}$ and $W_{y,out}$ for calculation of bending stresses due to out-of-plane bending about the strong (y) axis.
- $I_{x,out}$ and $W_{x,out}$ for calculation of bending stresses due to out-of-plane bending about the weak (x) axis.
- $A_{y,gross,out,V}$ for calculating shear stresses due to out-of-plane bending about the strong (y) axis.
- $A_{x,gross,out,V}$ for calculating shear stresses due to out-of-plane bending about the weak (x) axis.

Table 3.4 Table of section properties of 3-layer CLT

Dimension (mm)	Thickness per layer (mm)			Location of NA (mm)	Cross-sectional area per linear metre (cm ²)			For bending about Y axis per linear metre [Strong axis] (cm ⁴ , cm ³ , cm ²)			For bending about X axis per linear metre [Weak axis] (cm ⁴ , cm ³)		
	t_1	t_2	t_3		$A_{x,net}$	$A_{y,net}$	A_{CLT}	$I_{y,out}$	$W_{y,out}$	$A_{y,gross,out,V}$	$I_{x,out}$	$W_{x,out}$	$A_{x,gross,out,V}$
60	20	20	20	30	400	200	600	1,733	578	600	67	67	200
70	20	30	20	35	400	300	700	2,633	752	700	225	150	300
80	20	40	20	40	400	400	800	3,733	933	800	533	267	400
80	30	20	30	40	600	200	800	4,200	1,050	800	67	67	200
90	30	30	30	45	600	300	900	5,850	1,300	900	225	150	300
100	30	40	30	50	600	400	1,000	7,800	1,560	1,000	533	267	400
100	40	20	40	50	800	200	1,000	8,267	1,653	1,000	67	67	200
110	40	30	40	55	800	300	1,100	10,867	1,976	1,100	225	150	300
120	40	40	40	60	800	400	1,200	13,867	2,311	1,200	533	267	400

Table 3.5 Table of section properties of 5-layer CLT

Dimension (mm)	Thickness per layer (mm)					Location of NA (mm)	Cross-sectional area per linear metre (cm ²)			For bending about Y axis per linear metre [Strong axis] (cm ⁴ , cm ³ , cm ²)			For bending about X axis per linear metre [Weak axis] (cm ⁴ , cm ³)		
	t_1	t_2	t_3	t_4	t_5		$A_{x,net}$	$A_{y,net}$	A_{CLT}	$I_{y,out}$	$W_{y,out}$	$A_{y,gross,out,V}$	$I_{x,out}$	$W_{x,out}$	$A_{x,gross,out,V}$
100	20	20	20	20	20	50	600	400	1,000	6,600	1,320	1,000	1,733	578	600
120	20	30	20	30	20	60	600	600	1,200	10,200	1,700	1,200	4,200	1,050	800
140	20	40	20	40	20	70	600	800	1,400	14,600	2,086	1,400	8,267	1,653	1,000
110	20	20	30	20	20	55	700	400	1,100	8,458	1,538	1,100	2,633	752	700
130	20	30	30	30	20	65	700	600	1,300	12,458	1,917	1,300	5,850	1,300	900
150	20	40	30	40	20	75	700	800	1,500	17,258	2,301	1,500	10,867	1,976	1,100
120	20	20	40	20	20	60	800	400	1,200	10,667	1,778	1,200	3,733	933	800
140	20	30	40	30	20	70	800	600	1,400	15,067	2,152	1,400	7,800	1,560	1,000
160	20	40	40	40	20	80	800	800	1,600	20,267	2,533	1,600	13,867	2,311	1,200
120	30	20	20	20	30	60	800	400	1,200	12,667	2,111	1,200	1,733	578	600
140	30	30	20	30	30	70	800	600	1,400	18,667	2,667	1,400	4,200	1,050	800
160	30	40	20	40	30	80	800	800	1,600	25,867	3,233	1,600	8,267	1,653	1,000
130	30	20	30	20	30	65	900	400	1,300	15,675	2,411	1,300	2,633	752	700
150	30	30	30	30	30	75	900	600	1,500	22,275	2,970	1,500	5,850	1,300	900
170	30	40	30	40	30	85	900	800	1,700	30,075	3,538	1,700	10,867	1,976	1,100
140	30	20	40	20	30	70	1,000	400	1,400	19,133	2,733	1,400	3,733	933	800
160	30	30	40	30	30	80	1,000	600	1,600	26,333	3,292	1,600	7,800	1,560	1,000
180	30	40	40	40	30	90	1,000	800	1,800	34,733	3,859	1,800	13,867	2,311	1,200
140	40	20	20	20	40	70	1,000	400	1,400	21,133	3,019	1,400	1,733	578	600
160	40	30	20	30	40	80	1,000	600	1,600	29,933	3,742	1,600	4,200	1,050	800
180	40	40	20	40	40	90	1,000	800	1,800	40,333	4,482	1,800	8,267	1,653	1,000
150	40	20	30	20	40	75	1,100	400	1,500	25,492	3,399	1,500	2,633	752	700
170	40	30	30	30	40	85	1,100	600	1,700	35,092	4,128	1,700	5,850	1,300	900
190	40	40	30	40	40	95	1,100	800	1,900	46,292	4,873	1,900	10,867	1,976	1,100
160	40	20	40	20	40	80	1,200	400	1,600	30,400	3,800	1,600	3,733	933	800
180	40	30	40	30	40	90	1,200	600	1,800	40,800	4,533	1,800	7,800	1,560	1,000
200	40	40	40	40	40	100	1,200	800	2,000	52,800	5,280	2,000	13,867	2,311	1,200

Connections

- 4.1 Design principles 53
- 4.2 Overview of joint types 54
 - 4.2.1 Screws and dowels 54
 - 4.2.2 Standard metal plates and brackets 55
- 4.3 Joint details 55
 - 4.3.1 Joints in the CLT plane 55
 - 4.3.2 Surface joints in the CLT plane 56
 - 4.3.3 Connections to beams 56
 - 4.3.4 Wall-to-wall connections 57
 - 4.3.5 Wall-to-floor connections 58
 - 4.3.6 Wall-to-foundation, and wall-to-roof connections 58
- 4.4 Design of connections 60
 - 4.4.1 Nailed and screwed joints, general 60
 - 4.4.2 Shear capacity of self-drilling wood screws in CLT 60
 - 4.4.3 Withdrawal capacity for self-drilling wood screws in CLT 62
 - 4.4.4 Designing nail plates for CLT 64
 - 4.4.5 Permitted edge distances and spacings for nails, screws and dowels 67

Joints and their design usually have a major impact on how a structure behaves. The joints affect its load-bearing capacity, stiffness, stability and its fire and acoustic performance. The design of the joints also affects the type of failure that can occur.

The majority of joints in CLT structures make use of screws, metal plates and brackets along with nails or screws. The market offers a wide variety of self-drilling wood screws of various lengths that can be used directly for load-transferring joints. There is also a wide range of standard metal plates and brackets for various purposes.

When designing timber structures, the engineer needs to take several factors into account. These factors include the duration of the load, the service class and the load's direction in relation to the grain. The load direction is particularly important, as CLT is made up of several layers of boards in different directions. When designing wood joints, it is also vital that the structural engineer is familiar with the material's orthotropy and its hygroscopic properties.

A final warning is that many aspects of CLT connection design, such as screwing into the edge of a CLT panel, are not fully codified. It is therefore necessary to comply with the requirements of the relevant European Technical Assessments for both the screws and the CLT. Often these will not be the same, in which case the more onerous will apply.

A CLT building has many different joints and connecting details. Even a simple structure in CLT has several different junctions that require joint solutions, *see figure 4.1*. Each type of joint can be designed in many ways, and technical advances mean that more and

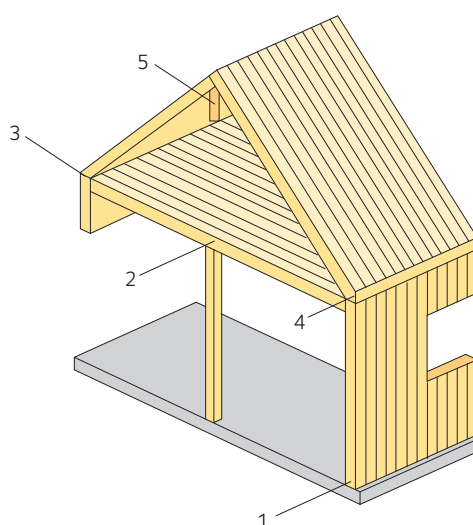

Figure 4.1 Joints in a CLT structure

1. Joint between wall panel and foundation.
2. Joint between post and floor slab.
3. Joint between wall panel and floor slab.
4. Joint between wall panel and roof.
5. Joint between ridge beam and roof.

more new fixings are coming onto the market. New fixings specifically for CLT are also constantly being developed. This chapter provides a brief description of the different joint types, each with a general outline of how to design such a joint. From a financial point of view, it is usually best to employ joint solutions that use proprietary fasteners and plates.

4.1 Design principles

Joints tend to be a structure's weak point, particularly in timber. It is therefore important to consider not just how a joint works in terms of strength, but also the joint's effect on other performance aspects. Joints are the load-bearing parts whose task is to connect different components of the structure. In timber, the main lines of action should normally coincide with the centroids of the structural elements in order to avoid secondary forces due to eccentricities. Stiff moment connections in timber are difficult to achieve and are generally best avoided; this is particularly the case with CLT because the panels are usually relatively thin. Most of the connections discussed in this section will behave as pinned connections.

The structural engineer must understand how the joint transfers forces and make this force transfer possible through careful design. Before the joint can be designed, the structural engineer's first task is to calculate the forces and moments. These forces and moments must then be transferred by the joint, and it is essential that correct mechanical models are used in this context.

Wood is a hygroscopic material with moisture-related movement. This is a key factor to consider when designing joints, so that the wood is allowed to expand and contract as humidity levels change without internal stresses becoming too great. Since wood's tensile strength perpendicular to the grain is relatively low, the timber could split when it dries out. In practice, because CLT panels are relatively stable in plane (because of the cross-lamination) and generally thin, the moisture-related movement on a global level across CLT plates is small and not usually an issue.

The current code design rules contain the modification factors k_{mod} and k_{def} , which take into account the fact that the strength decreases, and the deformation increases, when the moisture content rises.

There remains a lack of supporting data and established principles for CLT for connections. However, drawing on sound judgement and experience from glulam design, most cases can be resolved. A situation where there is a clear risk of splitting, for example, is when a fastener causes stresses perpendicular to the grain, as shown in figure 4.2; therefore this situation should be avoided. However, when fixing into the face of a CLT panel, the risk of a splitting failure is reduced, since the transverse layer of boards will usually spread out the tensile force. If the risk of splitting is checked using the same methods as for structural timber or glulam, the load-bearing capacity of the joint is thus underestimated.

Since CLT panels contain boards with a grain that runs in different directions (mostly with a difference of 90 degrees), it is crucial to think about the position of the fixings to avoid fixings into the end-grain or too short a fixing. The joint often causes a reduction in the design area and a weakening of the cross-section due to the penetrating screws, inset plates and dowels, and this also needs to be considered.

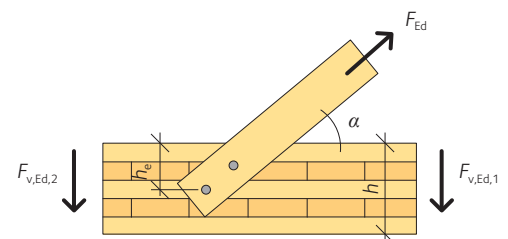

Figure 4.2 Risk of peeling caused by load perpendicular to the grain

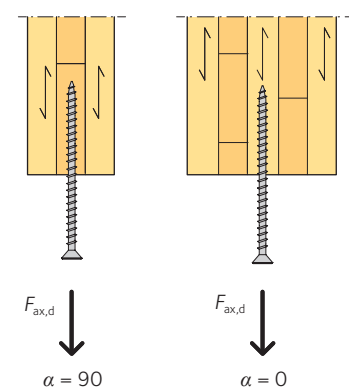

Figure 4.3 The withdrawal capacity of wood screws varies greatly, depending on whether they are positioned in a layer of boards whose grain is perpendicular to or parallel to the screws. The withdrawal strength of the screw arrangement to the right will be much lower than that on the left and should generally be avoided.

4.2 Overview of joint types



Roof made of glulam and CLT.

There are many different types of fixings that can be used for the joints between CLT walls and floor slabs, or joints between other materials and CLT. Long self-drilling wood screws are commonly used in joints between CLT panels, but other traditional fixings such as nails, flitch plates and nail plates are also widely used. There are also several more innovative solutions, such as glued-in rods, proprietary corner joints, and systems for invisible load-transferring joints. The new systems often rely on a high degree of prefabrication of CLT panels and the fact that CNC machines are used to fabricate the fixings.

4.2.1 Screws and dowels

Joints using various types of screws (see figure 4.4) are simple solutions widely used for fastening CLT.

The popularity of wood screws is due in part to their capacity to handle both shear forces and tensile forces, along with their ease of use on the construction site without pre-drilling. Self-drilling wood screws are made in diameters from 4 mm to 13 mm and in lengths of up to 1,000 mm. They are designed according to their area of use. For joints that use nail plates or other standard metal brackets, it is common to use what are sometimes referred to as “anchor” nails or “anchor” screws (figure 4.4).

Screws and dowels are commonly used in large wooden structures, particularly for joints with large shear forces. When using screws and dowels in CLT structures, specific consideration must be given to the position of the fixings, as there is a risk of the fastener being inserted into gaps between the boards when using non-edge-glued CLT panels. To transfer large shear forces, there are solutions that employ steel sleeves in the form of cylindrical rings, see figure 4.12, page 56, although these are not usually used in the UK.



Anchor nail. Used in combination with metal plates.

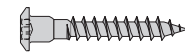

Anchor screw. Used in combination with metal plates.

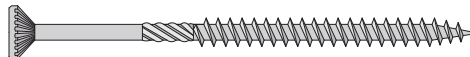

Wood construction screw. With specially designed threads. No need for pre-drilling.



Universal screw. With upper and lower threads of different pitches, to join two pieces of wood.



Self-drilling dowel. Used to assemble inset steel plates in wooden structures.

Figure 4.4 Examples of nails, screws and dowels that are used in CLT joints

4.2.2 Standard metal plates and brackets

Standard metal plates and brackets are an important type of fixing for joining floor slabs and wall panels in CLT. There are all sorts of angle brackets to choose between, from brackets that handle large tensile forces to brackets that are designed to mainly transfer shear forces.

Light duty angle brackets

Light duty angle brackets can be used for joints between floor slabs and wall panels under a moderate load. They are made from hot dip galvanised or stainless steel with a thickness of 2 to 4 mm and a hole diameter of 5 mm for anchor nails or anchor screws, *see figure 4.5*.

Heavy duty angle brackets

These are used for heavier loads and can also be used to fasten CLT to concrete (because they have larger holes suitable for expansion anchors) and are available in many dimensions. They are made from hot dip galvanised or stainless steel with a thickness of 2 to 3 mm and a hole diameter of 5 mm for nails or screws and larger holes for expansion anchors, *see figure 4.6*.

These are generally proprietary products and should be designed according to the manufacturer's European Technical Approval (ETAs).

Nail plates

Nail plates are a good option for moderate forces. Punched nail plates come in many variants. Punched plates are usually the most cost-effective alternative to drilled plates. The punching of plates requires the plate thickness not to exceed the hole diameter. The hole should be around 1 mm larger than the diameter of the fastener. The nail plates can be cast into the concrete slab or welded to cast-in plates, *see figure 4.31, page 64*.

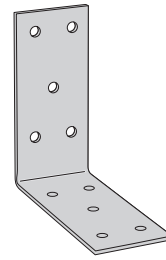

Figure 4.5 Light Duty Angle Bracket

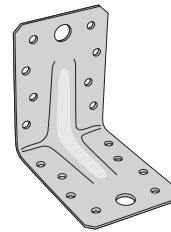

Figure 4.6 Heavy Duty Angle Bracket

4.3 Joint details

4.3.1 Joints in the CLT plane

Joints between CLT panels can be executed in several different ways: joints with a loose tongue; with single or double cover plates; half-lap joints; and similar solutions. The cover plate may be plywood, LVL, planed wood or steel. Below is a brief description of the various principles.

Joints with a loose tongue are a common solution, *see figure 4.7*.

The tongue can be screwed or nailed together. The joint can also have double tongues. The joint can transfer forces along and across the CLT's plane. The joint is rarely used in the UK because of difficulty of assembly.

Joints with single or double cover plates increase the capacity of the structure and the joint to transfer shear forces, *see figure 4.8 and 4.9*. The cover plates can be screwed or nailed in place.

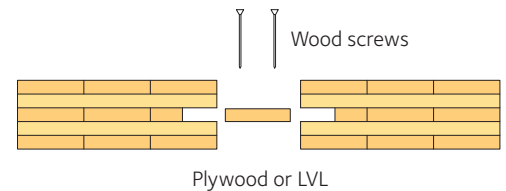

Figure 4.7 Joint with a loose tongue

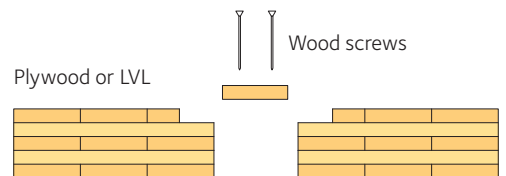

Figure 4.8 Joint with single cover plate

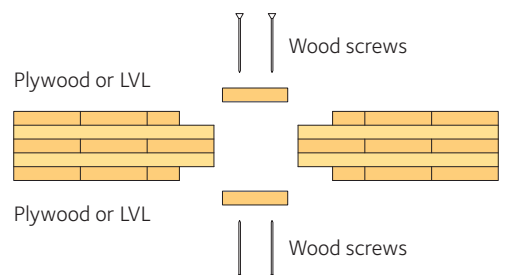

Figure 4.9 Joint with double cover plates

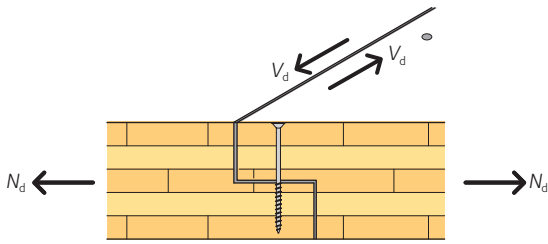

Figure 4.10 Half-lap joint

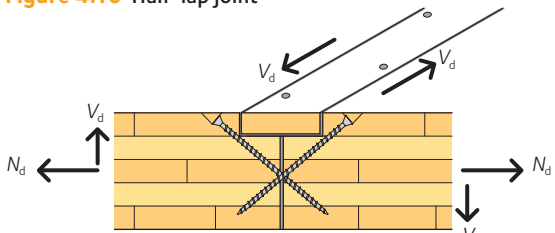

Figure 4.11 Joint with single cover plate and skew screwing

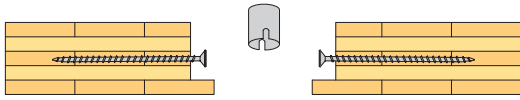

Figure 4.12 Joint with connecting steel sleeves and wood screws

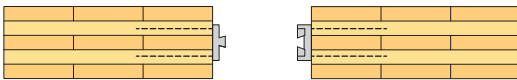

Figure 4.13 Joint with a specialist fixing, secured with skewed wood screws

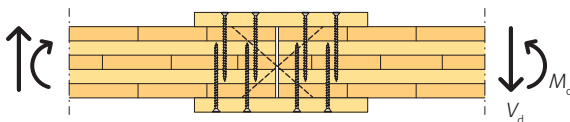

Figure 4.14 Weak moment connection perpendicular to span direction

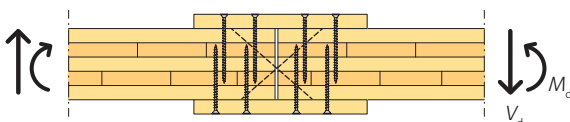

Figure 4.15 Weak moment connection in span direction

Half-lap joints are popular, see figure 4.10. The simplicity of the method when combined with self-drilling wood screws makes for rapid assembly. The joint can transfer forces along and across the CLT's plane.

Joints with a single cover plate and reinforced with diagonal self-drilling wood screws, see figure 4.11. The diagonal screws allow significant out-of-plane shear and tensile load transfer through the joint.

Joints with connecting steel sleeves, together with fully threaded screws, are another method that has been developed, although not often used in the UK, see figure 4.12. The screws are inserted by the CLT manufacturer, so that the steel sleeve with notches can easily be fitted on the construction site. The withdrawal strength of the threaded screws has proved to be critical for this type of joint. The joints can be designed for large tension forces along the length of the joint.

Joints with specialist fixings are available in various forms designed specifically for joining wooden structures, see figure 4.13. Many of the fixing systems are based on various keys.

The keys involve steel or aluminium brackets being screwed to the CLT wall panels so that the panels can then be fitted together. The number of brackets and their size determines the overall capacity of the joint.

4.3.2 Surface joints in the CLT plane

Joints in the CLT panel's plane that transfer small moments can be achieved if cover plates are added to the top and bottom of the CLT panels, see figures 4.14 and 4.15. The cover plates can also be placed in the outermost layers of the boards, see figure 4.9, page 55. This allows smooth surfaces to be achieved, but with less of a moment of resistance since the lever arms are reduced. The load-bearing capacity and stiffness of the joint also depend on the number of screws and the material chosen for the joint. Even with surface-mounted cover plates, less than half the panel capacity can be transferred.

4.3.3 Connections to beams

CLT panels are often used for large floor slabs, supported on steel or glulam beams. The design can be arranged in various ways, with a few of the possibilities presented below.

A common way to bridge gaps in the floor slab for openings, where you want smooth and even surfaces top and bottom, is to set steels into the CLT structure, see figures 4.16 a) – c), page 57. To achieve smooth surfaces, the structure can be covered with panels of plywood or LVL. These panels can in some cases be designed to transfer compression and tensile forces in the floor slab's plane. In cases where it can be accepted that there is no space for the steel within the thickness of the CLT panel, a very common solution is to use glulam beams, see figure 4.16 d), page 57. Glulam beams are also a common solution as internal support for continuous CLT panels, see figure 4.16 e), page 57. In the cases shown in figures 4.16 a) to d) it is necessary to check the beam for torsion due to unbalanced live load. Careful consideration also needs to be given to fire behaviour.

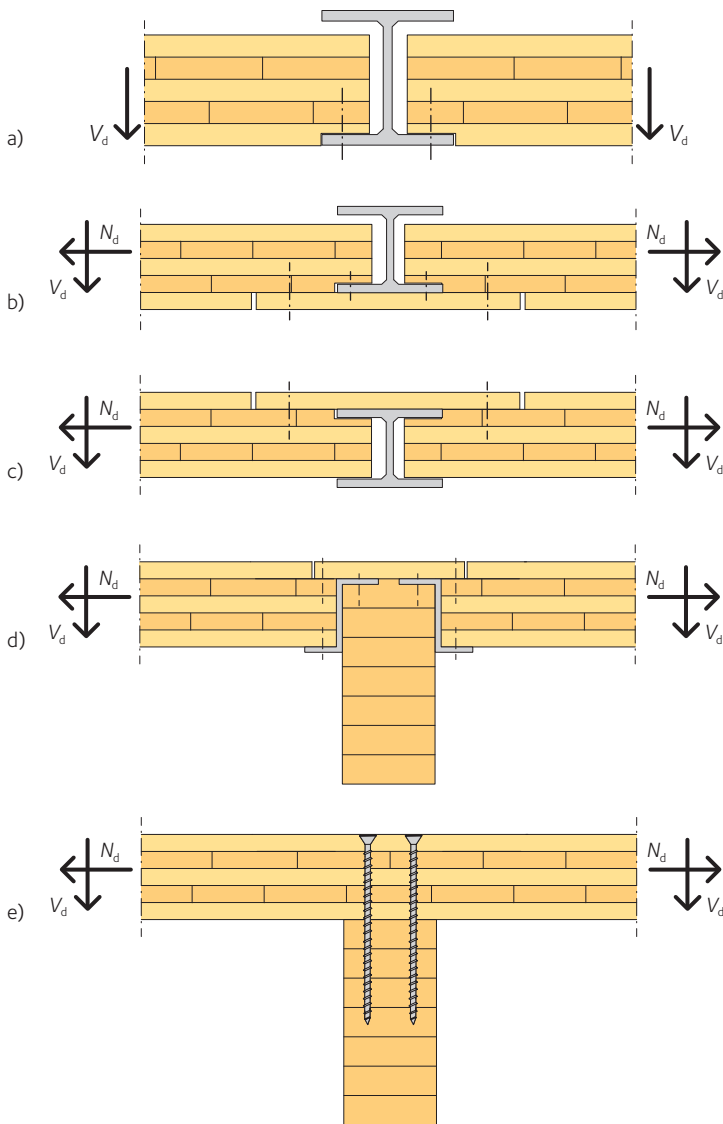

Figure 4.16 Examples of connections to beams

4.3.4 Wall-to-wall connections

Wall panels can in principle be joined with wood screws, angle brackets or concealed specialist fixings. Self-drilling wood screws and angle brackets are the most common choice but there are also other, more innovative, options. Additional features may be needed to improve a joint's fire and acoustic performance.

The simplest way of joining CLT to another wooden surface is usually to use self-drilling wood screws, see figure 4.17. It is, however, crucial to check the position of the screws to ensure they are not screwed only into end-grain, i.e. parallel with the grain. To minimise the risk of this, and in cases where screwing is only possible from the side, skew screwing may be an alternative.

Another simple system is to use angle brackets, see figure 4.18. This method is effective at transferring shear forces. It is, however, less suitable for visible surfaces. The market also offers specially designed fixings, both visible and invisible.

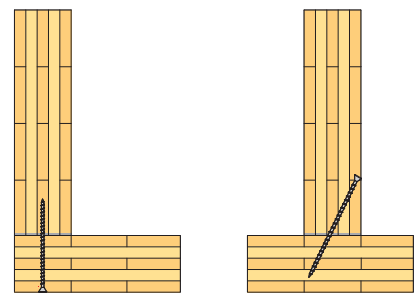

Figure 4.17 Joint using screws, horizontal cross-section.

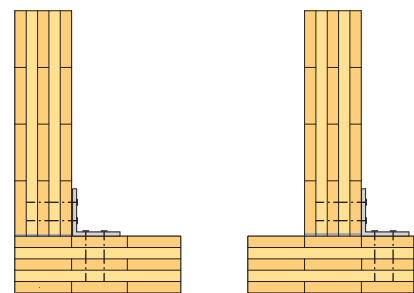

Figure 4.18 Joint using angle brackets, horizontal cross-section.

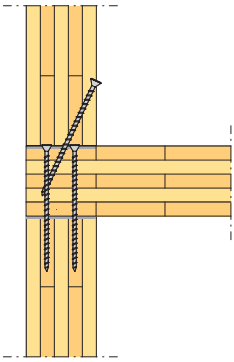

Figure 4.19 Joint between wall panel and floor slab using long wood screws

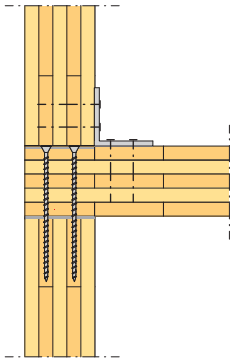

Figure 4.20 Joint between wall panel and floor slab using an angle bracket

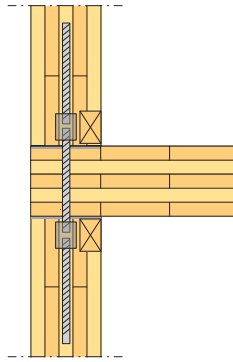

Figure 4.21 Joint between wall panels and floor slab using fully threaded rods and dowels

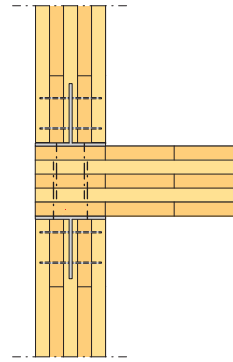

Figure 4.22 Joint between wall panels and floor slab using slotted-in steel tees

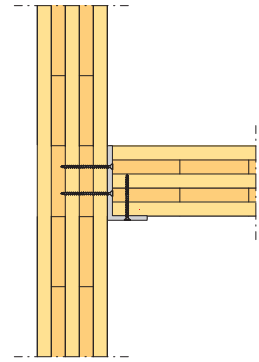

Figure 4.23 Joint between wall panel and floor slab using an angle bracket

4.3.5 Wall-to-floor connections

The simplest method of joining a wall panel to a floor slab is to use long self-drilling screws. These can be inserted through the floor structure above directly into the CLT panel below. The wall panel above is in turn connected with skew screwing. Instead of long wood screws, angle brackets can be used. Additional measures may be needed to improve the joints for fire and acoustics.

Joints between a wall panel and a floor slab can be connected with long self-drilling wood screws, *see figure 4.19*. The method is simple, but care must be taken not to screw into end-grain and to ensure that the necessary anchorage lengths are achieved.

Joints between a wall panel and a floor slab can also be connected with angle brackets, *see figure 4.20*. Angle brackets tend to be stronger in shear than screws. The brackets can be fixed in place using nails or screws.

Joints between wall panels and floor slabs can also be connected with long or short fully threaded rods, *see figure 4.21*. Short glued-in rods in each end of the wall panel combined with threaded sleeves create an assembly system that is tailored to CLT panels. Rods the length of the wall height could potentially be used to carry wind-overturning forces down to the foundation.

Joints between wall panels and floor slabs can also be connected with inset fixings, *see figure 4.22*. Inset fixings, where the fixings are first screwed into the CLT, are concealed inside the wall panels and fixed in place with dowels.

Joints between wall panels and floor slabs can also be connected with a longitudinal angle bracket, *see figure 4.23*.

4.3.6 Wall-to-foundation, and wall-to-roof connections

Wall panel connections used in CLT structures normally form non-moment-resisting joints. The wall panel can be connected to the foundation by casting brackets into the concrete slab or welding them to fixing plates that are cast into the concrete. Alternatively, the brackets can be anchored in the concrete using expansion screws

or chemical anchors. Wall ends that sit directly on concrete, brick, lightweight blocks or other hygroscopic material should be fitted with a moisture barrier. However, it is also recommended to sit CLT walls on an upstand to protect them from water damage during construction.

A simple and common way to connect to the foundation is to use a nail plate or angle bracket, *see figure 4.24*. The brackets are fitted using nails or screws. This type of connection is suitable for both large and small horizontal forces.

When attaching wall panels to roofs, all the connecting options mentioned in *section 4.4.5, page 67*, can be used. The simplest form of connection and the most common is to use self-drilling wood screws, *see figure 4.25*.

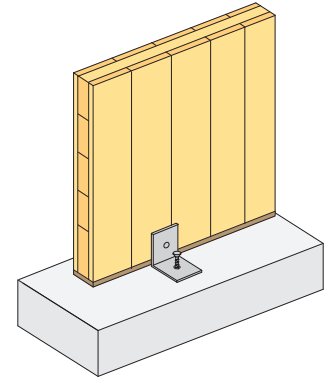

Figure 4.24 Connecting to the foundation using angle bracket

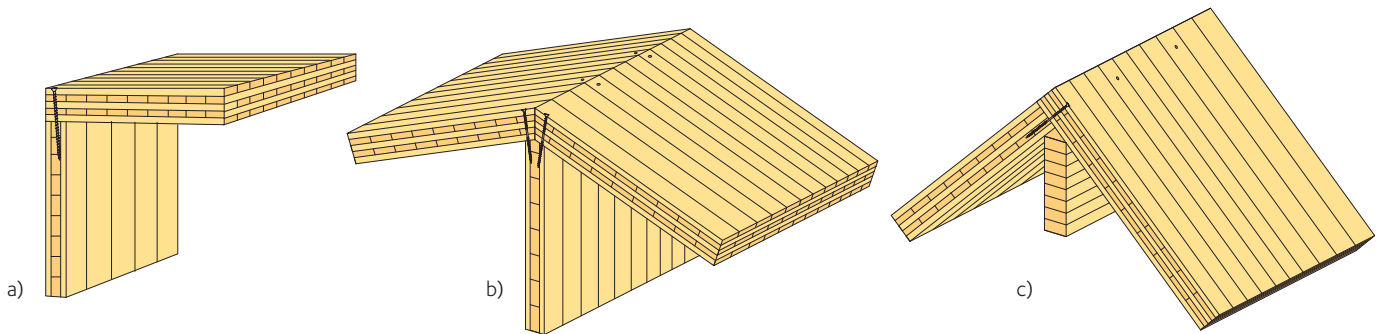
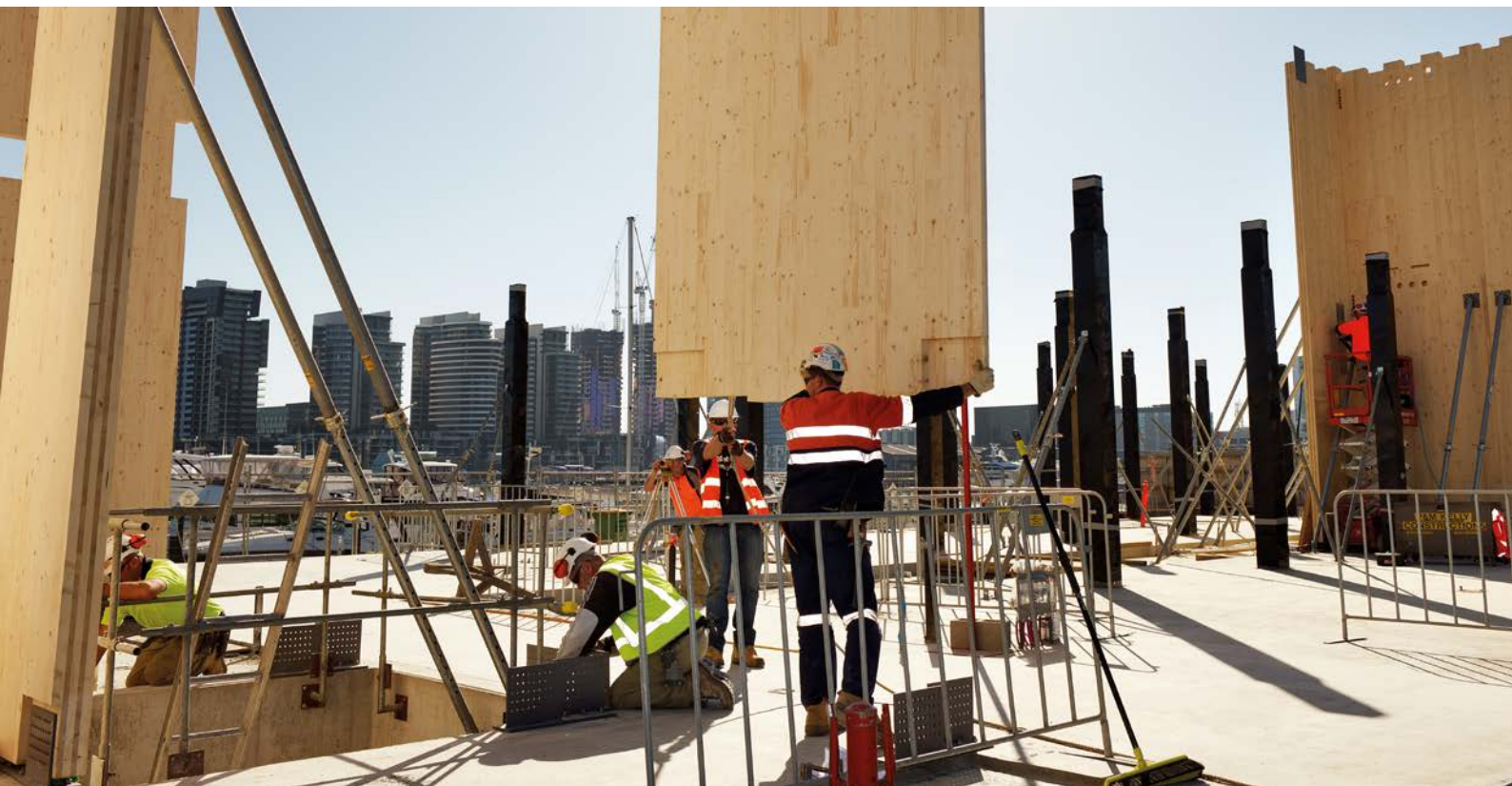

Figure 4.25 Connecting a wall panel and glulam ridge beam to a CLT roof



Assembly of CLT walls.

4.4 Design of connections

4.4.1 Nailed and screwed joints, general

The values and methods presented in this chapter are largely based on the values and methods developed by Uibel and Blass 2006–2007, and also the latest manufacturer ETAs at the time of writing. In most cases, manufacturers of wood screws, nails and brackets will provide their own characteristic strengths for their products, based on testing. Screwed joints are designed according to the shear forces and tensile forces that are transferred by those joints. Compression forces are normally transferred via contact pressure between the wooden components, but may also be transferred via the screwed joints.

When designing joints, the following failure modes should be checked:

- Shear of the screw.
- Withdrawal and pull-through of the wood screws.
- Combined shear and withdrawal of the wood screws.
- Shear and tension on the wood screws (steel failure).
- Compression in the joint perpendicular to the grain.
- Group failure of the screws.

The joint's load-bearing capacity should be designed in line with *Eurocode 5, chapter 8.2* for shear forces and *Eurocode 5, chapter 8.7* for withdrawal forces. The interaction between shear forces and withdrawal forces is designed in line with *Eurocode 5, chapter 8.3*.

The load-bearing capacity of the screw steel is checked in accordance with Eurocode 3 or the manufacturer's ETA. Consideration must also be given to splitting and any block shear failure; if following Eurocode 5 or *The Swedish Wood Glulam Handbook Part 2* for this, the values you get will generally be on the safe side due to the cross-lamination of the CLT.

4.4.2 Shear capacity of self-drilling wood screws in CLT

CLT is unusual, compared with solid timber and glulam, since the connection takes place in a sheet with two "main directions" for the fibres. This means that account must be taken of the board layers that are being fixed into. The results of the calculations will vary depending on the direction of the layers.

Uibel and Blass have developed a couple of models for calculating characteristic embedment strength, $f_{h,k}$ for screws inserted perpendicular to the plane. The design models are empirical, based on several tests. Self-drilling wood screws are the most common method of connection when building with CLT. The equations stated below are based on a large number of tests with wood screws with a minimum tensile strength of $f_{u,k} = 800 \text{ N/mm}^2$.

Shear resistance of self-drilling wood screws perpendicular to the CLT panel's plane

The shear resistance of wood screws is determined largely by the embedment strength of the CLT.

The equation below can be used to calculate the embedment strength of self-tapping non-predrilled screws into the wide face of the CLT panel. It should be noted that for predrilled screws the embedment strength is likely to be higher.



Screwed joint, CLT.



Assembly of a summer house, Skellefteå, Sweden.

$$f_{h,ek} = \frac{0.082 \rho_k d^{-0.3}}{2.5 \cos^2 \varepsilon + \sin^2 \varepsilon}$$

where:

- $f_{h,k}$ is the characteristic embedment strength.
- d is the wood screw's outer thread diameter.
- ρ_k is the characteristic dry density of wood.
- ε is the angle between the screw and the plane of the CLT plate.

The equation is valid under the following conditions:

- wood screw outer thread diameter d is in the range 6 to 13 mm
- anchorage length is greater than $4d$
- the wood screw's effective length in the CLT panel must cover at least three board layers.

When calculating the load-bearing capacity of the joint, Johansen's theory in Eurocode 5 should be used. For a joint with a group of wood screws, a reduction in the number of wood screws is required. Therefore the capacity of a screw group is given by the capacity of a single screw multiplied by an effective number of screws (n_{ef}). Where n_{ef} maybe conservatively taken as the following for screw groups with screws greater than 6 mm outer diameter:

$$n_{ef} = 0.74n^{0.9}$$

The effective number of screws for screw groups with screws of outer diameter of 6 mm or more with a spacing of at least $7d$ can be taken as:

$$n_{ef} = n^{0.7}$$

where:

- n_{ef} is the effective no. of wood screws.
- n is the no. of wood screws in the joint.

Shear resistance of self-drilling wood screws fixed into the CLT panel's edge

The load-bearing capacity of wood screws under a shear force in the CLT panel's edge is calculated using the equation below and is valid under the conditions stated below. It applies to wood screws perpendicular to the grain.

$$f_{h,k} = 20d^{-0.3}$$

where:

- $f_{h,k}$ is the characteristic embedment strength.
- d is the wood screw's outer diameter in millimetres.

The equation is valid under the following conditions:

- wood screw outer thread diameter $d \geq 6$ mm
- effective penetration length, $l_{ef} \geq 10 \times d$ mm
- gaps between boards < 2 mm.
- The grain in layer the lamella the screw is inserted into should be perpendicular to the screw axis.
- Screws embedded into the narrow face of the CLT should not be loaded perpendicular to the face of the CLT. Loading should only be in the sense shown in figure 4.27.

4.1

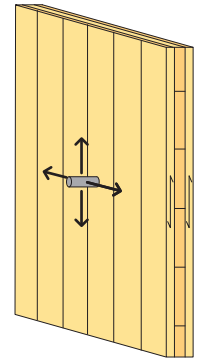

Figure 4.26 Wood screws fixed perpendicular to the CLT panel's plane

Table 4.1 Embedment strength, $f_{h,k}$ for wood screws perpendicular to the panel's plane, fully threaded screws and wood material with characteristic density of 350 kg/m³

Wood screw diameter d (mm)	Embedment strength, $f_{h,k}$ (N/mm ²)
6	16.8
7	16.0
8	15.4
9	14.8
10	14.4
11	14.0
12	13.6

4.2

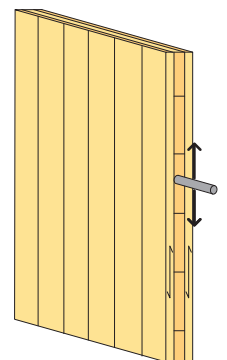

Figure 4.27 Wood screws fixed into CLT panel's edge and loaded parallel to the edge
Loads perpendicular to the edge should be avoided.

Table 4.2 Embedment strength, $f_{h,k}$ for wood screws in edge (narrow face) of CLT panel, fully threaded screw and wood material with characteristic density of 350 kg/m³

Wood screw diameter d (mm)	Embedment strength, $f_{h,k}$ (N/mm ²)
6	8.0
7	7.5
8	7.0
9	6.7
10	6.3
11	6.0
12	5.8



Lifting CLT panels at the factory.

The effective number of screws for screw groups with screws of outer diameter greater than 6 mm can be taken as:

$$n_{ef} = 0.74n^{0.9}$$

The effective number of screws for screw groups with screws of outer diameter of 6 mm with a spacing of at least $7d$ can be taken as:

$$n_{ef} = n^{0.7}$$

where:

- n_{ef} is the effective no. of wood screws.
- n is the no. of wood screws in the joint.

4.4.3 Withdrawal capacity for self-drilling wood screws in CLT

When calculating characteristic withdrawal capacity, $F_{ax,Rk}$, for self-drilling wood screws fixed into the face of the panel, equation 4.3 can generally be used. Equation 4.3 is based on test results. The characteristic density of the wood material should amount to $\rho_k \approx 350 \text{ kg/m}^3$.

$$4.3 \quad F_{ax,Rk} = \frac{31 \times d^{0.8} \times l_{ef}^{0.9}}{1.5 \times \cos^2 \alpha + \sin^2 \alpha}$$

where:

- $F_{ax,Rk}$ is the characteristic withdrawal capacity.
- d is the wood screw's outer thread diameter in millimetres.
- ρ_k is the characteristic density of CLT when connecting perpendicular to the plane, and the characteristic density for the relevant boards when connecting along the edge, usually $\rho_k \approx 350 \text{ kg/m}^3$.
- l_{ef} is the wood screw's effective anchorage length in the wood; a minimum effective anchorage length of $l_{ef,min} = 4d$ is required.
- α is the angle between the screw and the grain direction. This should always be greater than 30.

The embedment length only relates to the threaded part of the wood screw.

The effective number of screws should be taken as equation 4.4 (from EN 1995-1-1):

$$4.4 \quad n_{ef} = n^{0.9}$$

where:

- n_{ef} is the effective no. of screws.
- n is the no. of screws that interact in the joint.

Withdrawal capacity of wood screws fixed into the edge of CLT panel

The withdrawal capacity of wood screws in the edge of CLT panels can be calculated using equation 4.5, page 63, and applies under the stated conditions. Two different cases can occur: wood screws perpendicular to the grain, and wood screws parallel to the grain.

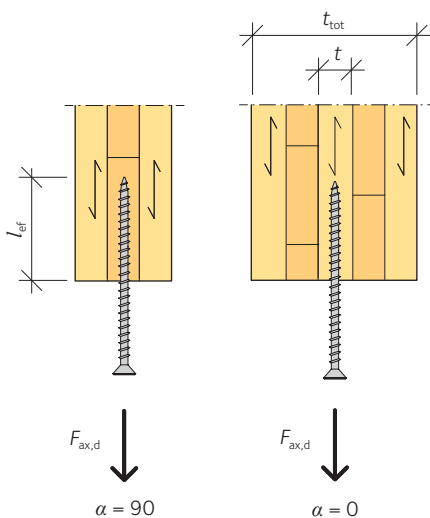

Figure 4.28 Wood screw in edge of panel, perpendicular to the grain and parallel with the grain. The right-hand condition should be avoided.

For connections perpendicular to the grain, a conservative assumption is made, since the wood screws are not placed with any certainty on the centreline of the cross-section. The factor for the wood screw's angle to the grain, α , is therefore set at zero, which gives:

$$F_{ax,Rk} = \frac{31 \times d^{0.8} \times l_{ef}^{0.9}}{1.5}$$

where:

- d is the wood screw's outer thread diameter in millimetres.
- l_{ef} is the effective anchorage length.

The equation is valid under the following conditions:

- outer thread diameter for wood screw, $d \geq 6$ mm
- effective anchorage length, $l_{ef} \geq 10 \times d$
- thickness of board into which screw is driven, $t \geq 3 \times d$
- total panel thickness, $t_{tot} \geq 10 \times d$
- characteristic density, $\rho_k \approx 350$ kg/m³.

Screws in withdrawal (and generally) parallel to the grain should be avoided, as at the time of publishing *The CLT Handbook* only a few long-term tests have been carried out. If screwing is needed into the layer with fibres oriented at 90 degrees to the edge face, the screws should be angled at around 30 degrees to the grain, or greater, and ideally placed in pairs (figure 4.29). This means that the wood screws will cut through several fibres, which will increase the load-bearing capacity of each wood screw.

Tables 4.3 and 4.4 state the characteristic withdrawal capacity for screws into the face and edge of a panel respectively. The validity of the equations as discussed above applies.

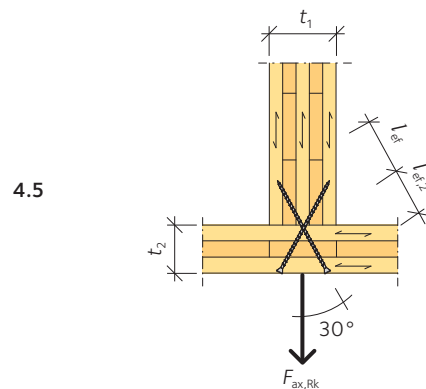

Figure 4.29 Skew screwed joint.

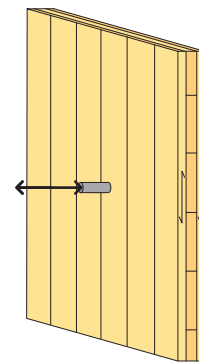

Figure 4.30 Screws perpendicular to the CLT panel in withdrawal.

Table 4.3 Characteristic withdrawal capacity, $F_{ax,Rk}$ in kN for certain wood screw diameters and lengths.

Wood screw perpendicular to side face of CLT panel, anchorage length as in table and wood material characteristic density of 350 kg/m³.

Screw outer thread diameter (mm)	Screw anchorage length (mm)				
	50	100	150	200	250
6	4.4	8.2	11.8	15.3	18.7
8	5.5	10.3	14.9	19.3	23.5
10	6.6	12.3	17.8	23.0	28.2
12	7.7	14.3	20.6	26.6	32.6

Table 4.4 Characteristic withdrawal capacity, $F_{ax,Rk}$ in kN for certain wood screw diameters and lengths.

Wood screw perpendicular to edge face of CLT panel, anchorage length as in table and wood material characteristic density of 350 kg/m³.

Screw outer thread diameter (mm)	Screw anchorage length (mm)				
	50	100	150	200	250
6	2.9	5.5	7.9	10.2	12.5
8	3.7	6.9	9.9	12.8	15.7
10	4.4	8.2	11.9	15.4	18.8
12	5.1	9.5	13.7	17.8	21.7



Innovative joint solutions, X-RAD.

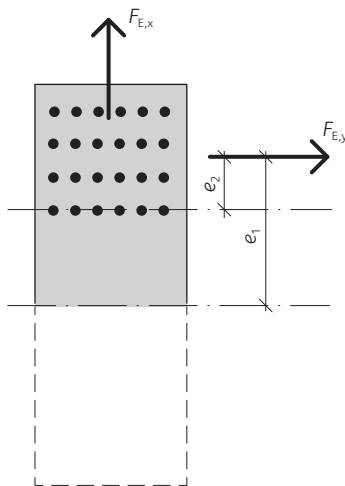

Figure 4.31 Connecting a CLT panel using a steel plate
Schematic diagram. The plate can be fastened using nails or screws.

4.4.4 Designing nail plates for CLT

Wall panels can be connected to foundations or to each other using steel plates. Plates with varying hole patterns, thicknesses and finishes can be ordered from manufacturers that sell punched plates and brackets. The price is usually lowest if the holes are punched, which means that the thickness of the metal plate must not exceed the diameter of the holes. The holes should be around 1 mm larger than the outer diameter of the fastener.

Check of steel plate

This type of joint transfers vertical compression forces via contact between the CLT panel and the foundation. The nails transfer the horizontal force $F_{E,y}$ and any vertical tensile force $F_{E,x}$ to the steel plate, which in turn channels them down to the foundation, see figure 4.31. Fixing plates cast into concrete or plates that are welded to cast-in plates are usually considered to be a fixed foundation bracket.

The following failure modes should be checked:

- shear stress in CLT
- block shear, see Eurocode 5, Appendix A
- steel plate failures caused by moment, axial force and shear force (both gross cross-section and net cross-section)
- buckling of the steel plate caused by axial force.

When checking the shear of the nailed connection, the horizontal force and any vertical tensile force are assumed to act at the nail group's centre of mass. The resulting force F_E is then as set out in the following equation (it is assumed the plates are on both sides of the CLT; if the plate is only on one side of the CLT then effects due to eccentricities should be checked):

$$4.6 \quad F_E = \sqrt{F_{E,x}^2 + F_{E,y}^2}$$

To determine the number of nails, values for the capacity per fastener, $F_{v,Rd}$ are used as set out in Eurocode 5 or verified values from the manufacturer. For nails with a diameter of less than 8 mm, the load-bearing capacity is the same, whatever the direction of the force. The number of nails, n , can thus be determined using equation 4.7:

$$4.7 \quad n = \frac{F_E}{F_{v,Rd}}$$

If the centre-spacing of the nails in the direction of the grain is set at a minimum of $14d$, you do not need to limit the effective number of nails in a row, see Eurocode 5, table 8.1. If standardised nail plates are used, the distance is also determined by the hole pattern of the plate.

Block shear failure in the joint can be checked in accordance with Eurocode 5, Appendix A. If the steel plate is subject to a vertical and a horizontal force, the eccentricity of the horizontal force causes a bending moment. In the solid part of the steel plate (figure 4.31), the gross section moment becomes:

$$4.8 \quad M_E = F_{E,y} \times e_1$$

In the row of holes with the greatest stress (the net section), the following applies:

$$4.9 \quad M_E = F_{E,y} \times e_2$$

Stresses in the steel plate's different cross-sections are calculated based on the moment and the vertical and horizontal forces. If the steel plate is thin, it may be necessary to check the risk of the plate buckling. If the spacing of the fasteners in the steel plate is executed as recommended, buckling does not need to be checked. The plate's connection to the foundation should also be checked.

Checking the steel stresses

Steel plates are checked in line with Eurocode 3 – Design of steel structures. Various failures may occur in steel plates: tensile, compression, shear and bending failures, and a combination of these and hole edge failures, although hole edge failures with standard dimensions are uncommon.

In the case of tensile failures in steel plate, the whole cross-section and the net cross-section (the part of the cross-section that remains once the holes for the fasteners have been considered) are checked. Load-bearing capacity $N_{pl,Rd}$ for the whole cross-section can be calculated using *equation 4.10*:

$$N_{pl,Rd} = \frac{f_y \times A}{\gamma_{M0}} \quad 4.10$$

The load-bearing capacity $N_{u,Rd}$ for the net cross-section is:

$$N_{u,Rd} = \frac{0.9 \times f_u \times A_{net}}{\gamma_{M2}} \quad 4.11$$

$$\gamma_{M2} = 1.1 \quad 4.12$$

where:

- f_y is the yield point for the steel material.
- f_u is the ultimate strength of the steel material.
- A is the gross area of the steel plate's cross-section.
- A_{net} is the net area of the steel plate (through a row of holes).
- γ_{M0} is the partial factor for the material, here 1.0 in the UK.

Compression failure in the steel plate is checked and the load-bearing capacity under stress $N_{c,Rd}$ is calculated using *equation 4.13*:

$$N_{c,Rd} = \frac{f_y \times A}{\gamma_{M0}} \quad 4.13$$

where:

- f_y is the yield point for the steel material.
- A is the gross area of the steel plate's cross-section.
- γ_{M0} is the partial factor for the material, here 1.0.

Buckling of the steel plate between fasteners need not be checked if the distance between the fasteners is less than a_1 and where a_1 can be expressed:

$$a_1 \leq 9t \times \varepsilon = 9t \sqrt{\frac{235}{f_y}} \quad 4.14$$

where:

- f_y is the yield stress of the steel material.
- t is the thickness of the steel plate.
- ε is a dimensionless factor for determining the cross-section class of the steel plate.



Supported roof of CLT, Flyinge, Lund, Sweden.

If the distance between the fasteners is greater than a_1 , the plate is checked by treating it as a compression strut with a buckling length of $0.6a_1$.

Buckling of the steel plate between the base of the plate and the first row of holes should also be checked taking account of the rotational restraint provided by the base and the connection of the wall plate.

Bending failures in the steel plate are checked, and the load-bearing capacity $M_{c,Rd}$ during bending when the cross-section is fully plastic is calculated, using *equation 4.15*, for moment rotating about the centre of mass of the cross-section:

$$4.15 \quad M_{c,Rd} = \frac{W_{pl} \times f_y}{\gamma_{M0}}$$

where:

W_{pl} is the plastic bending resistance of the steel plate.

f_y is the yield stress for the steel material.

γ_{M0} is the partial factor for the material, here 1.0.

For a rectangular cross-section:

$$4.16 \quad W_{pl} = \frac{b \times h^2}{4}$$

where:

h is the height of the cross-section.

b is the width of the cross-section.

The effect of the holes in the compression zone does not need to be considered if the holes are filled with a fastener. In the tensile zone, the holes do not need to be considered as long as the following is met:

$$4.17 \quad \frac{A_{net} \times 0.9 \times f_u}{\gamma_{M2}} \geq \frac{A \times f_y}{\gamma_{M0}}$$

$$4.18 \quad \gamma_{M2} = 1.1$$

where:

f_y is the yield point for the steel material.

f_u is the ultimate strength of the steel material.

A is the gross area of the steel plate's cross-section.

A_{net} is the net area of the steel plate (through a row of holes).

γ_{M0} is the partial factor for the material, here 1.0.

Shear failure in the steel plate is checked and load-bearing capacity $V_{c,Rd}$ calculated using *equation 4.19* if the whole cross-section becomes fully plastic:

$$4.19 \quad V_{c,Rd} = V_{pl,Rd} = \frac{A_v (f_y / \sqrt{3})}{\gamma_{M0}}$$

where:

f_y is the yield stress for the steel material.

A_v is the shear area of the steel plate's cross-section, which can be taken as $0.9A$.

γ_{M0} is the partial factor for the material, here 1.0.

Provided $V_{ed} < 0.5V_{pl,Rd}$ effect of shear on direct stresses due to axial force and bending does not need to be considered.

4.4.5 Permitted edge distances and spacings for nails, screws and dowels

To fully exploit the load-bearing capacity and avoid splitting, minimum requirements for edge distance and spacing between the fasteners must be met. Details of edge distance and spacing can be found in tables 4.5 – 4.8 and figures 4.32 – 4.33, page 68.

Table 4.5 Minimum spacing and end/edge distance for self-drilling wood screws in the face of the CLT

Wood screws with outer diameter ≥ 6 mm. See figure 4.32, page 68.

Reference (referring to figure 4.32 and 4.33)	Spacing/distance
a_1	$4d$
a_2	$2.5d$
$a_{3,t}$	$6d$
$a_{3,c}$	$6d$
$a_{4,t}$	$6d$
$a_{4,c}$	$2.5d$

Table 4.6 Minimum spacing and end/edge distance for nails and dowels into the face of the CLT

See figure 4.32, page 68.

Fastener	a_1	a_2	$a_{3,t}$	$a_{3,c}$	$a_{4,t}$	$a_{4,c}$
Nail	$(3+3 \cos\alpha)d$	$3d$	$(7+3 \cos\alpha)d$	$6d$	$(3+4 \cos\alpha)d$	$3d$
Dowel	$(3+2 \cos\alpha)d$	$4d$	$5d$	$4d \sin\alpha$ (min. $3d$)	$3d$	$3d$

Table 4.7 Minimum spacing and end/edge distance for self-drilling wood screws in the edge of the CLT panel with outer thread diameter ≥ 6 mm

See figure 4.33, page 68.

Reference (referring to figure 4.32 and 4.33)	Spacing
a_1	$10d$
a_2	$3d$
$a_{3,t}$	$12d$
$a_{3,c}$	$7d$
$a_{4,c}$	$5d$

Table 4.8 Minimum wood thicknesses. See figure 4.33, page 68.

Fastener	Minimum thickness of layer into which fixing is inserted t (mm)	Minimum total thickness of panel t_{tot} (mm)	Minimum anchorage length (mm)
Wood screw	$d > 8$ mm: $3d$ $d \leq 8$ mm: $2d$	$10d$	$10d$
Dowel	$8d$	$6d$	$5d$

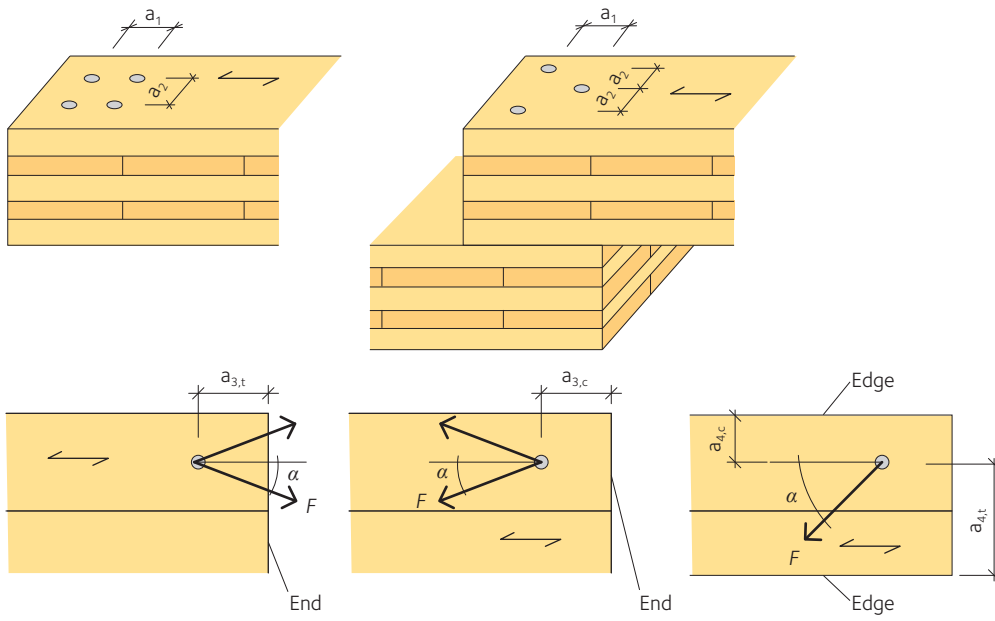

Figure 4.32 Minimum spacing and edge distance for nails, screws and dowels in the plane of the CLT panel

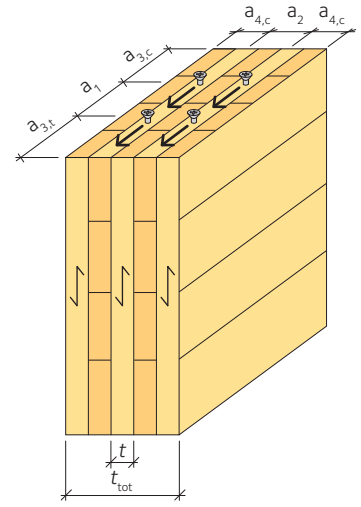

Figure 4.33 Minimum spacing and end/edge distance for nails, screws and dowels in the edge of the CLT panel

Floors

Floors and their design often have a major impact on the user's perception of a building. The design of the floor also affects the building's load-bearing capacity and stability, as well as its fire safety and acoustic performance. A good design will give you a floor that is quiet, stable and comfortable. There are various ways to construct a CLT floor, which can be grouped into three main categories:

- Slabs
- Ribbed slabs and cassettes
- CLT concrete composite floors.

A CLT slab is a simple CLT panel that, if necessary, can have finishes and insulation added. A ribbed CLT slab is a CLT slab with glued ribs to provide extra stiffness. In a cassette floor, spaced web joists are sandwiched between two CLT slabs to create a stressed skin. A CLT concrete composite floor involves CLT slabs working compositely with an in-situ concrete topping. All of these are suitable for prefabrication.

When designing wooden structures, the engineer needs to take a number of factors into account. These factors include load duration, service class, and the load's direction in relation to the grain, a particularly important consideration since CLT is made up of layers of boards in different directions. When designing timber joints, it is also vital that the structural engineer is well-versed in the material's orthotropy and its moisture properties.

5.1 Floors – overview

A floor is a horizontal load-bearing structural element that separates the different storeys of a building above and/or below it. A floor comprises a load-bearing part that is usually accompanied by a further separating layer and finally a surface layer in the form of carpet or wood flooring and a ceiling. The floor needs to be designed for horizontal and vertical loads such as self-weight, imposed load, and wind load, individually or in combination. Similarly, serviceability requirements including deflection and vibration must also be satisfied. The floor must also be designed so that it complies with requirements for fire safety, sound and thermal insulation. Although CLT panels are theoretically two-way spanning, because they are narrow and usually only supported on two parallel edges, they are generally designed as one-way spanning.

Although the load-bearing boards in the main direction of the load have the greatest effect on the panel's properties, account must be taken of transverse layers in stiffness calculations. Rolling shear failures can occur in CLT when the wood fibres roll or slide over each other under shear stress across the fibres, resulting in greater shear deformations and lower shear capacity.

5.1	Floors – overview	69
5.1.1	CLT floor slab	70
5.1.2	Ribbed slabs	70
5.1.3	CLT concrete composite floor	70
5.2	Deformations	72
5.2.1	Slab deformation	72
5.2.2	Load combinations	73
5.2.3	Calculation methods	74
5.3	Dynamics	74
5.3.1	Inputs and assumptions for floor vibration analysis	75
5.3.2	Response factor method	76
5.4	Fire safety	81
5.5	Acoustic performance	82
5.6	Details	82
5.7	Example	84
5.7.1	ULS design of floor	84

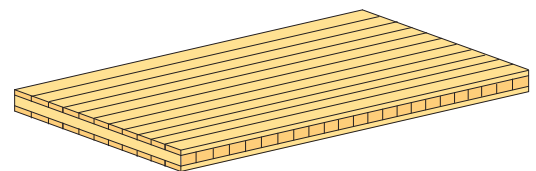

Figure 5.1 CLT slab



Orsman Road apartments, London, England.

5.1.1 CLT floor slab

A CLT slab is the simplest form of CLT floor. The CLT panel alone carries the load and distributes it to the underlying structure. The build-up of the panel, in terms of number and thickness of layers, is determined by the structural, dynamic, fire and acoustic requirements. To meet sound and fire safety requirements, there will usually need to be additional layers on the top, bottom or sometimes both.

The cross-laminated boards of the CLT slab give the floor structure transverse stiffness and also little in the way of moisture-related movement.

5.1.2 Ribbed slabs

Bonding glulam joists to the underside or top of the CLT slab enables the floor structure to handle larger loads and longer spans. The floor structure comprises a CLT slab and web joists with or without flanges. Additional details/layers are often required to meet sound and fire safety requirements. The voids in the floor structure can be filled with mineral wool insulation, for example, and the underside can be fitted with a sprung suspended ceiling of plasterboard on battens. Even better acoustic separation can be achieved if the sub-ceiling is kept entirely separate from the floor structure above, *see figure 5.2*. Pipes and wiring can also be run through the voids.

5.1.3 CLT concrete composite floor

This type of floor structure mainly comprises two parts, a CLT slab on the underside and an in-situ concrete topping.

Usually, notches in the CLT or some form of shear connector are used to join the CLT to the concrete and so increase the bending stiffness of the structure. From a structural point of view, this type of structure is highly efficient, as you make optimum use of the materials' properties, i.e. the compressive strength of the concrete and the tensile strength of the wood. A CLT concrete composite floor has higher bending stiffness than an equivalent wooden floor structure of the same depth. This means that longer spans can be achieved. In addition, the dynamic performance is generally better, since the damping is often greater.

Another positive aspect of this type of structure is the stiffness of the concrete slab in-plane, which means that horizontal loads caused, for example, by wind, can be spread evenly between the shear walls. The acoustic performance is also often better with a CLT concrete composite floor.

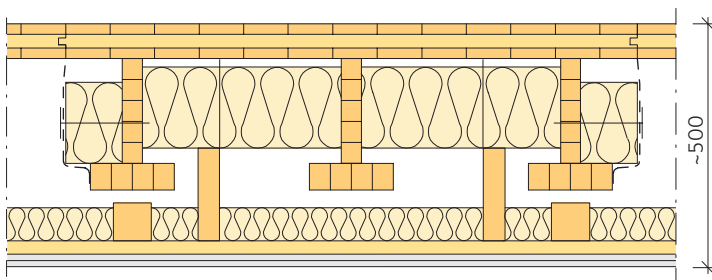

Figure 5.2 Example of a ribbed floor, with CLT slab reinforced by glulam web joists and flanges plus a suspended ceiling. By separating the floor and ceiling structure, better acoustic separation can be achieved.

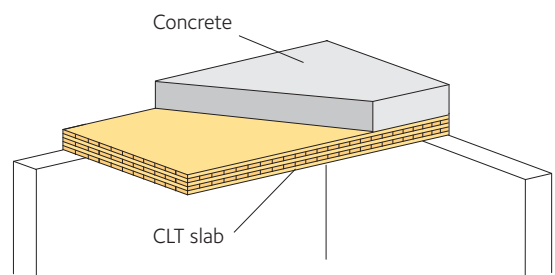

Figure 5.3 Composite floor structure in two parts, schematic

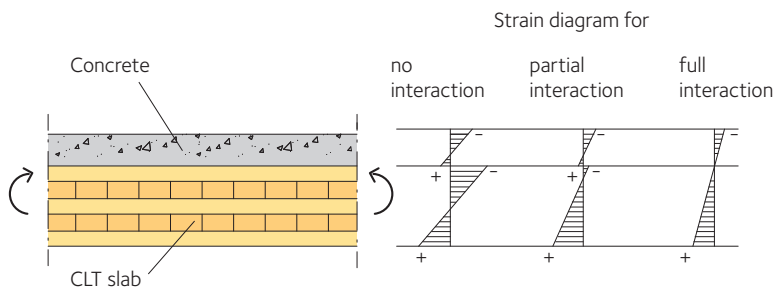

Figure 5.4 Strain diagram of composite floor with varying degrees of interaction. The strains shown in the figure are caused by bending.

CLT concrete composite floor structure with partial interaction

It tends to be difficult to achieve full interaction between wood and concrete. This section briefly describes composite components with partial interaction, where the transfer of shear forces between the wood and concrete parts causes more than negligible sliding in the joint. *Figure 5.3, page 70*, shows part of a simply supported floor structure that comprises two parts, a CLT slab and a concrete topping, with partial interaction.

Figure 5.4 shows that, in the deformed state, a displacement has occurred in the joint between the component parts. This displacement varies from zero at the midspan to a peak value at the supports. This displacement generates forces in the shear connectors that join the two parts of the floor structure. If you have a sufficiently large number of shear connectors and/or choose shear connectors with extremely high shear stiffness, sliding between the wood and concrete is negligible, which means that full interaction between the materials can be assumed when designing the floor structure. On the other hand, where the number of shear connectors is very small, and their shear stiffness is low, the sliding between the two materials can occur almost unhindered, which means that no interaction at all can be assumed in designing the floor structure. In normal cases, the shear stiffness of the shear connectors is neither infinite nor zero, but somewhere in between, creating partial interaction, *see figure 5.4*.

The shear connectors have a critical impact on the behaviour of the floor. The choice of shear connectors is a compromise between effectiveness and economy: the shear connectors must be as stiff as possible and at the same time quick and easy to install. There are a number of shear connectors that meet these requirements to a lesser or greater extent. These include:

- Glued in perforated steel plate
- Screws
- A large notch in the top surface of the CLT slab.

A shear connector of type HBV, Holz-Beton-Verbund, is a proprietary perforated steel plate that is inserted longitudinally into the top surface of the CLT slab and bonded with a polyurethane or epoxy glue, *see figure 5.5*.

Another simple way to ensure good interaction between wood and concrete is to cut a notch in the CLT surface with screws screwed into the notch. The main purpose of the screws is to take up any tensile force that occurs between the sections of wood and concrete when the floor structure is put under a load, *see figure 5.6*.

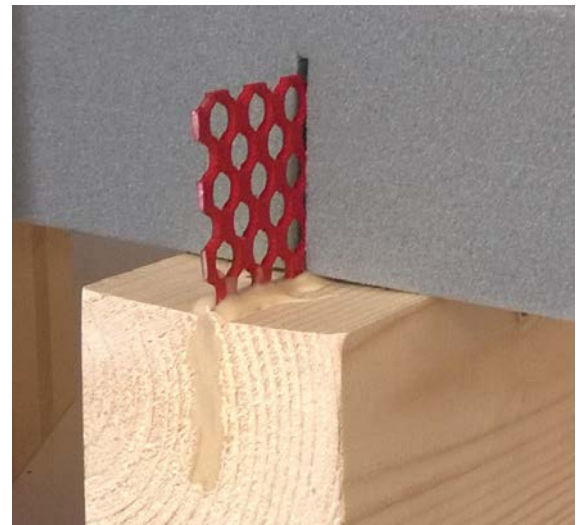

Principle of interaction between wood and concrete with shear connector of type HBV.

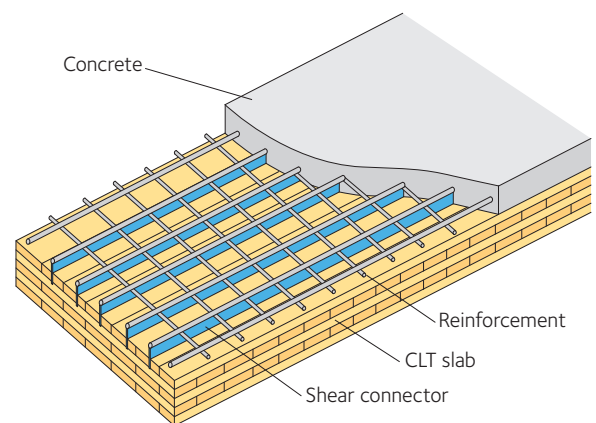

Figure 5.5 Composite floor structure in CLT and concrete, with HBV shear connectors (Holz-Beton-Verbund)

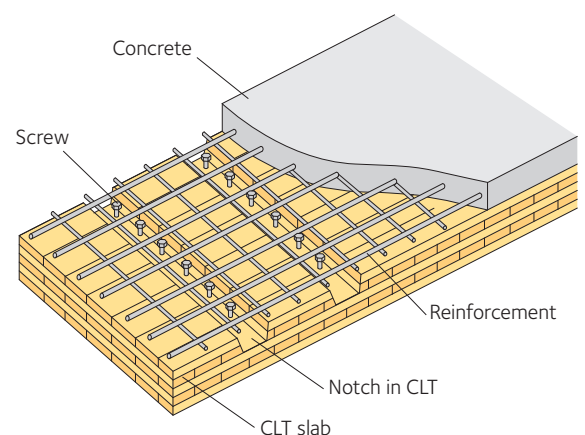

Figure 5.6 Composite floor in CLT and concrete, where the interaction is achieved via a notch in the upper surface of the CLT slab



Office building, Älta, Sweden.

Designing timber concrete composite floor structures: principles and rules of thumb

Composite floor structures made from CLT and concrete are suitable for spans of 6 – 12 m. A preliminary value for the total cross-section height h_{tot} can be calculated as $h_{tot} \approx L/25$, where L is the span of the floor structure. The thickness of the concrete slab h_b is normally chosen as $h_b \approx 0.4 \times h_{tot}$, making the thickness of the CLT slab $h_{CLT} \approx 0.6 \times h_{tot}$. During the preliminary design of the floor structure, where the dynamic performance usually governs, it can be assumed that the level of interaction is around 85 percent and 70 percent when using shear connectors as set out in figure 5.5, page 71, and figure 5.6, page 71, respectively.

In other words, it is assumed that the composite floor in question has an effective bending stiffness that is respectively around 85 percent and 70 percent of the bending stiffness of a corresponding floor structure with full interaction – depending on the choice of shear connector.

Design for the ultimate limit state is mostly done in two stages. The first stage is to calculate the cross-sectional properties and corresponding stresses in the wood and in the concrete, using the short-term modulus of elasticity.

The second stage involves checking the cross-section based on the materials' long-term properties. The effect of concrete shrinkage should also be taken into account. Account is taken of long-term effects by reducing the modulus of elasticity by the associated creep coefficients stated in Eurocode 2 and Eurocode 5, for concrete and wood respectively. This stage often governs the design in the ultimate limit state.

5.2 Deformations

5.2.1 Slab deflection

The serviceability limit state usually governs the design of CLT floors in housing and offices. The strength utilisation is usually less than 50 percent. When designing for the serviceability limit state, both deflection and vibration should be considered. The floor should be modelled as an orthotropic slab with different strength and stiffness properties in the two directions.

For most designs, the load comprises a permanent component G and a variable component Q_i . For wooden structures, where variable loads generally dominate, deflection varies during the lifetime of the structure.

For a structural component subject to a constant load during its lifetime, deflection is determined based on the initial deflection, w_{inst} , the material's creep, w_{creep} , and the deformation factor, k_{def} which is determined by the moisture content of the wood material and the variation in that moisture content.

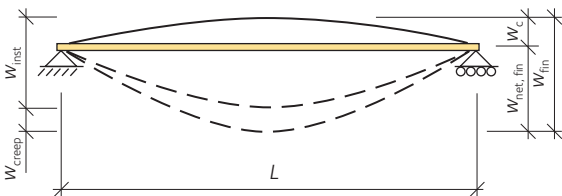

Figure 5.7 Definitions of deflection

- W_{inst} is instantaneous deflection.
- W_{creep} is deflection caused by creep.
- W_c is any pre-camber.
- W_{fin} is final deflection.
- $W_{net,fin}$ is final net deflection.

Table 5.1 Recommended deflection limits for various load combinations in EN 1995-1-1

Structural component	w_{inst}	$w_{net,fin}$	w_{fin}
Beam with two supports (max 20 mm)	$L/300 - L/500$	$L/250 - L/350$	$L/150 - L/300$

$$w_{creep} = k_{def} w_{inst} \quad 5.1$$

The final deformation under permanent actions can thus be expressed as:

$$w_{fin,G} = w_{inst,G} + w_{creep,G} = w_{inst,G} (1 + k_{def}) \quad 5.2$$

and for variable actions:

$$w_{fin,Q_i} = w_{inst,Q_i} + w_{creep,Q_i} = w_{inst,Q_i} (1 + \psi_{2,i} k_{def}) \quad 5.3$$

Since the creep depends on the length of time for which the load is applied, the factor ψ_2 has been introduced to account for this effect. For floors, it is typical to use service class 1 ($k_{def} = 0.8$ or 0.85) and quasi-permanent values for variable actions.

A specific deflection limit can be chosen based on functional requirements or for visual reasons. Experience has shown that a deflection of $L/300$ ($w_{net,fin}$) is the lowest acceptable value with a small safety margin. When designing floor structures in storage spaces it is, however, often acceptable to permit deflections in the order of $L/200 - L/150$ ($w_{net,fin}$). Table 5.1 shows some recommended deflection criteria.

5.2.2 Load combinations

When making deflection calculations, checks should be made based on the loads that are expected to apply for the structure in question. For floor structures there are generally three different load combinations that may be relevant: characteristic, frequent and quasi-permanent. The load combinations usually used are expressed in equations 5.4, 5.5 and 5.6.

The Characteristic combination is normally used when short-term deformations, w_{inst} , are calculated:

$$\sum_{j \geq 1} G_{k,j} + Q_{k,1} + \sum_{i > 1} \psi_{0,i} Q_{k,i} \quad 5.4$$

The Frequent combination is used to estimate reversible deformations:

$$\sum_{j \geq 1} G_{k,j} + \psi_{1,1} Q_{k,1} + \sum_{i > 1} \psi_{2,i} Q_{k,i} \quad 5.5$$

The Quasi-permanent combination is used to determine long-term effects in the form of creep in the final deformation:

$$\sum_{j \geq 1} G_{k,j} + \sum_{i \geq 1} \psi_{2,i} Q_{k,i} \quad 5.6$$

where:

- $G_{k,j}$ are load effects of permanent actions.
- $Q_{k,1}$ is the variable leading action.
- $\psi_{0,i}$, $\psi_{1,1}$, $\psi_{2,i}$ are load combination factors.
- $Q_{k,i}$ are other variable actions.



Roof made of glulam and CLT.

5.2.3 Calculation methods

The deflection calculations for floor structures are performed using a number of load combinations. The simplest method of calculating a flat plate floor structure's deflection due to self-weight and external load is to treat the slab as one-way spanning strips resting on two supports. Since half-lap and lap joints along the long sides of CLT panels are generally not capable of transferring significant vertical shear at ULS, CLT floors should always be considered as one-way spanning for ULS situations.

The floor slab's deflection can then be calculated using the applied moment. If the ratio between the span, L , and the slab's thickness, h_{CLT} , is less than 10, account must also be taken of the shear deformation.

For a floor structure that is simply supported on two supports, the deflection in the middle of the span due to bending moment can be calculated using *equation 5.7*:

$$5.7 \quad w_m = \frac{5ql^4}{384(EI)_{\text{eff,out}}}$$

where:

q is the uniformly distributed load.

L is the span.

$(EI)_{\text{eff,out}}$ is as per *Chapter 3, page 34*.

The deflection depends not only on the bending moment but also on the shear forces.

The proportion of the shear deformation depends on the slab's modulus of elasticity E , the panel's shear modulus G and the ratio between the slab's thickness h_{CLT} and the span L . The shear deformation is likely to be of greater significance for floors with low L/h_{CLT} ratios.

The shear deformation's contribution w_s to the total deformation can be calculated using *equation 5.8*:

$$5.8 \quad w_s = \frac{ql^2}{8\kappa G_0 A_{\text{net}}}$$

where:

κ is the shear correction factor (as per *Chapter 3, page 34*).

G_0 is the parallel-to-grain shear stiffness.

A_{net} is the area with grain parallel-to-spanning direction.

5.3 Dynamics

Dynamic effects that occur, for example, when people walk on a floor, affect our perception of the quality of a building.

The performance of the floor depends on the floor's stiffness, mass and damping. The floor's stiffness depends on the floor's span and panel layup. Finishes such as partitions also affect the stiffness of floors, but as their effect is very hard to estimate accurately, it is conservative to neglect the contribution of partitions to the stiffness of a floor.

The mass of the floor depends on the density of the floor panel, its size, the mass of the finishes, and a realistic proportion of live load (generally $0.1 \times$ live load for standard residential or office floors).

The damping ratio of the floor depends on the build-up of the floor and finishes such as partitions.

Vibrations caused by people are a problem that occurs in the use phase. People walking around on a floor often tolerate greater vibrations than people who are sitting still, reading or writing. Vibrations may be felt by the person causing them, or it might be the activities of others that cause the vibrations.

It is also important to note that CLT panels that are continuous between rooms can transfer vibrations between different rooms. Vibrations from a neighbouring room are often felt to be more irritating than when the source of the vibrations is in the same room. This is a particular problem where the neighbouring space is under different ownership. One way to prevent this is to stop the CLT slab at the party wall line.

The method for assessing dynamic performance given in this manual is based on the Response Factor method, based on the work carried out by Willford et al, which was subsequently published in the Concrete Centre publication entitled 'A Design Guide to Footfall Induced Vibration of Structures'. The method has been developed to be applicable to all materials and works well for floors where the modal mass is no less than ten times that of the walker and is therefore generally suitable for CLT. Where the modal mass is less than 10 times that of the walker the method tends to overestimate the floor response, as it doesn't account for beneficial interaction between the floor and the walker.



The IVY Restaurant, Manchester, England.

5.3.1 Inputs and assumptions for floor vibration analysis

Table 5.2 Inputs and assumptions for floor vibration analysis

Inputs	Assumptions
CLT floor panel to either CLT wall, glulam beam or steel beam	These connections should be assumed to be pinned connections.
CLT floor panel to CLT floor panel fixity along the long edge of the CLT panel	This may be assumed to be a fixed connection transferring both moment and vertical shear in the dynamic case provided that outer layers are parallel to the spanning direction.
Supports	ULS requirements only require that a CLT floor is supported on two opposing sides depending on the main spanning direction of the CLT. However, for the dynamic case, it is advisable to provide some nominal fixity along the other two edges as well. This fixity serves two purposes: it prevents visible deflection between the floor edge and the wall when the floor vibrates; and it allows for two-way spanning action in the dynamic case, which is generally beneficial.
Effect of partitions	Partitions have an effect on the stiffness, mass and damping of a floor system. The mass may be accounted for in modelling and calculations, idealised as an appropriate UDL. The increase in system stiffness and damping due to partitions is hard to estimate and should be conservatively ignored.
Mass	In general there are two parts of a dynamic check: a frequency check, where more mass is more onerous as it reduces frequency; and a response check, where more mass is beneficial. Due to this and the fact that vibration is an SLS check, using a realistic value of mass is recommended. This generally tends to be approximately the unfactored dead and superimposed dead load and 10 percent of the unfactored live load.
Damping ratio	EN 1995 suggests a damping ratio of 0.01 for bare timber. However, in practice timber floors tend to have much higher levels of damping due to finishes (screed, partitions etc.). At scheme design stage a damping ratio of at least 0.02 is justified. The damping ratio has little effect on transient response but will have a significant effect on resonant response.
Weight of walker	A walker weight of 760 N is recommended.
Stride length	A stride length of 0.9 m is recommended.
Walking frequencies	1 – 2 Hz within office bays and residential rooms. 1 – 2.5 Hz in corridor and circulation areas.



Summer house, Skellefteå, Sweden.

5.3.2 Response factor method

The response factor method aims to work out a vibration response factor (R), which is used as a measure of floor performance:

$$5.9 \quad R = \frac{\text{Vibration response}}{\text{Minimum perceptible vibration level}}$$

In the above equation, the vibration response can be either velocity or acceleration.

An R value of 8 is considered suitable for a standard office floor, whilst an R value of 4 is considered suitable for a high quality office floor. As human perception of vibration is very subjective, vibration criteria should be agreed with the building's stakeholders.

There are two types of floor behaviour when considering vibration. The first is resonant response. Resonant response can occur on floors with natural frequencies up to four times the walking frequency, as the higher harmonics of a walk can excite the floor. A human walk can be idealised as a periodic function of force applied to the floor. Like all periodic functions it can be decomposed into harmonics (sine waves) with different amplitudes and frequencies. A human walk can have up to four significant harmonics. The frequency of a harmonic is given by the harmonic number multiplied by the walking frequency. This is why resonant response can occur at up to 4 times the walking frequency. The second is transient response, where response due to each footfall dies out almost completely before the next footfall occurs.

For floors up to four times the maximum walking frequency, both transient and resonant response factors should be calculated and checked, although for most cases it is the resonant response that is likely to govern.

For floors with natural frequencies greater than four times the walking frequency, only the transient response needs to be checked. Whilst not always possible, it is generally sensible to avoid resonant response by ensuring that the floor frequency is greater than four times the walking frequency.

For transient response, all modes up to twice the frequency of the first mode should be considered. For resonant response, all modes up to 15 Hz should be considered (this is because even off-resonant modes can be amplified).

Transient Response

1. All modes with frequencies up to twice the fundamental frequency should be calculated, to obtain modal mass, stiffness and frequency.

The effective footfall impulse (I_{eff}) for each mode is then calculated from equation:

$$I_{\text{eff},m} = \frac{54 f_w^{1.43}}{f_{n,m}^{1.3}} \quad 5.10$$

where:

f_w is the walking frequency.
 $f_{n,m}$ is the natural frequency of mode m .

2. The peak velocity in each mode, $v_{M,\text{Peak}}$ is given by:

$$v_{M,\text{Peak}} = \mu_{e,m} \mu_{r,m} \frac{I_{\text{eff},m}}{m_m} \quad 5.11$$

where:

$\mu_{e,m}$ is the value of mode shape at excitation point (i.e. location of the walker). Conservatively taken as 1.

$\mu_{r,m}$ is the value of mode shape at response point (i.e. location of the person feeling the vibration). Conservatively taken as 1.

m_m is the modal mass of mode m .

and from this the velocity response in each mode over the period of one footfall T ($v_m(t)$ from $t = 0$ to $t = T$) is calculated:

$$v_m(t) = v_m e^{-2\pi\zeta f_{n,m}t} \sin(2\pi f_{n,m}t) \quad 5.12$$

where:

T is the period of one footfall and is equal to $1/f_w$.

ζ is the damping ratio.

3. The total response as a function of time to each footfall is found by summing the velocity responses in each mode and given by:

$$v(t) = \sum_{m=1}^N v_m(t) \quad 5.13$$

where:

$v(t)$ is the total velocity at time t and N is the number of modes.

From the resulting velocity time history, a Root Mean Square (RMS) response can be evaluated over the period of one footfall:

$$v_{\text{RMS}} = \sqrt{\frac{1}{T} \int_0^T v(t)^2 dt} \quad 5.14$$

4. The response factor can be calculated by dividing this by the baseline RMS velocity for $R = 1$ ($v_{R=1}$) at the fundamental frequency, f_1 :

If $f_1 < 8\text{Hz}$ $v_{R=1} = (5 \times 10^{-3}) / (2\pi f_1)$ m/s

If $f_1 > 8\text{Hz}$ $v_{R=1} = 1.0 \times 10^{-4}$ m/s

$$R = \frac{v_{\text{RMS}}}{v_{R=1}} \quad 5.15$$



Single-family house, Nacka, Sweden.

Resonant response

1. Calculate the harmonic forcing frequency, f_h :

$$5.16 \quad f_h = hf_w$$

where h is the number of the harmonic.

2. Calculate the harmonic force, F_h , at this harmonic frequency for each mode, m .

$$5.17 \quad F_h = \text{DLF} \times \text{Weight of walker}$$

where DLF is the dynamic load factor.

Weight of walker may be taken to be 760 N.

3. Calculate the real and imaginary acceleration ($a_{\text{real,h,m}}$, $a_{\text{imag,h,m}}$) in each mode up to 15 Hz:

$$5.18 \quad a_{\text{real,h,m}} = \left(\frac{f_h}{f_m}\right)^2 \frac{F_h \mu_{e,m} \mu_{r,m} \rho_{h,m}}{m_m} \frac{A_m}{A_m^2 + B_m^2}$$

$$5.19 \quad a_{\text{imag,h,m}} = \left(\frac{f_h}{f_m}\right)^2 \frac{F_h \mu_{e,m} \mu_{r,m} \rho_{h,m}}{m_m} \frac{B_m}{A_m^2 + B_m^2}$$

where:

$$A_m = 1 - \left(\frac{f_h}{f_m}\right)^2 \quad \text{and} \quad B_m = 2\zeta \frac{f_h}{f_m}$$

$\rho_{h,m}$ is the factor that accounts for the fact that full resonant build up may not always occur. It can be calculated using the equation below or it can be conservatively taken as 1.

$$5.20 \quad \rho_{h,m} = 1 - e^{-2\pi\zeta \left[0.55h \frac{L}{I}\right]}$$

where:

h is the harmonic number.

L is the span of the floor.

I is the stride length.

4. Sum the real and imaginary responses in all modes to give the total real and imaginary acceleration to this harmonic force, a_h :

$$5.21 \quad a_{\text{real,h}} = \sum_m a_{\text{real,h,m}}$$

$$5.22 \quad a_{\text{imag,h}} = \sum_m a_{\text{imag,h,m}}$$

Table 5.3 Design values of DLF

Harmonic number, h	Harmonic forcing frequency (Hz)	Design value of DLF
1	1 – 2.8	Min{0.41(f -0.95), 0.56}
2	2 – 5.6	0.069 + 0.0056 f_h
3	3 – 8.4	0.033 + 0.0064 f_h
4	4 – 11.2	0.013 + 0.0065 f_h

5. Find the magnitude of this acceleration $|a_h|$ which is the total response in all modes to this harmonic (at this frequency):

$$|a_h| = \sqrt{a_{\text{real},h}^2 + a_{\text{imag},h}^2} \quad 5.23$$

6. Convert this acceleration to a response factor, R_h . First calculate the baseline peak acceleration for a response factor of 1 at this harmonic frequency, $a_{R=1,h}$. Divide this into the total acceleration response for this harmonic:

$$\text{If } f_h < 4 \text{ Hz} \quad a_{R=1,h} = \frac{0.0141}{\sqrt{f_h}} \text{ m/s}^2 \quad 5.24$$

$$\text{If } 4 \text{ Hz} < f_h < 8 \text{ Hz} \quad a_{R=1,h} = 0.0071 \text{ m/s}^2 \quad 5.25$$

$$\text{If } f_h > 8 \text{ Hz} \quad a_{R=1,h} = 2.82\pi f_h \times 10^{-4} \text{ m/s}^2 \quad 5.26$$

$$R_h = \frac{|a_h|}{a_{R=1,h}} \quad 5.27$$

7. Find the total response factor, R , which is the 'square root sum of squares' of the response factor for each of the four harmonics:

$$R = \sqrt{R_1^2 + R_2^2 + R_3^2 + R_4^2} \quad 5.28$$

Hand method

This method can be used for single or double span rectangular floors that are supported on walls on all four sides, as shown in figure 5.8 (where L is the main spanning direction and B is the width).

Calculation of the natural frequency:

$$f_1 = k_e k_{fm} \frac{\pi}{2L^2} \sqrt{\frac{(EI)_L}{\bar{m}}} \quad 5.29$$

$$k_e = \sqrt{1 + \left(\frac{L}{B}\right)^4 \frac{(EI)_T}{(EI)_L}} \quad 5.30$$

where:

- f_1 is the natural frequency of first mode.
- k_e is the factor accounting for two-way action in the main spanning direction.
- k_{fm} is the factor accounting for the increase in frequency due to the back span. This factor is given in figure 5.9, page 80.
- $(EI)_L$ is the effective stiffness in the longitudinal direction (strong direction) in Nm^2/m .
- $(EI)_T$ is the effective stiffness in the transverse direction (weak direction) in Nm^2/m .
- \bar{m} is the mass per unit area in kg/m^2 .

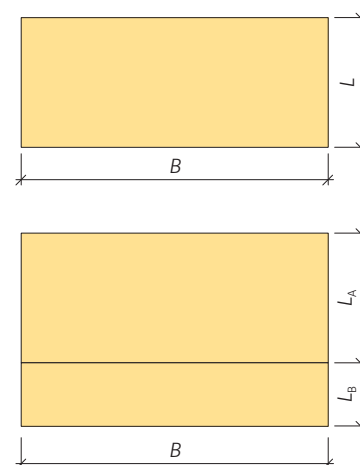

Figure 5.8 Definition of symbols for single and double span floors

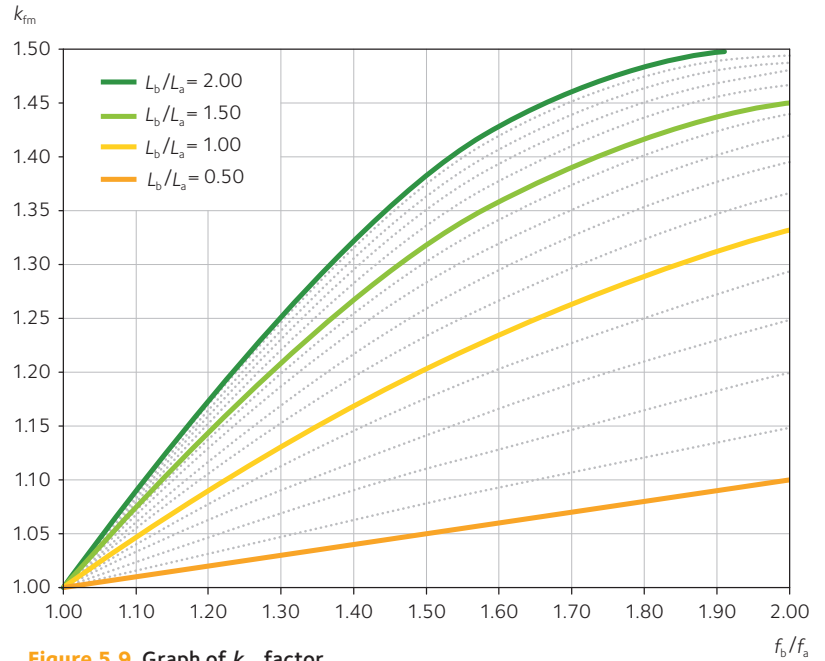

Figure 5.9 Graph of k_{fm} factor

In figure 5.9 f_a is the frequency of bay a , assuming it is single-spanning and simply supported, and f_b is the frequency of bay b , assuming it is single-spanning and simply supported.

The modal mass is calculated as follows, where bays are supported on four sides by walls in the dynamic case:

$$5.31 \quad m = \frac{\bar{m}BLk_{mm}}{4}$$

k_{mm} For single span floors this factor is 1. For double span floors this factor can be taken from figure 5.10.

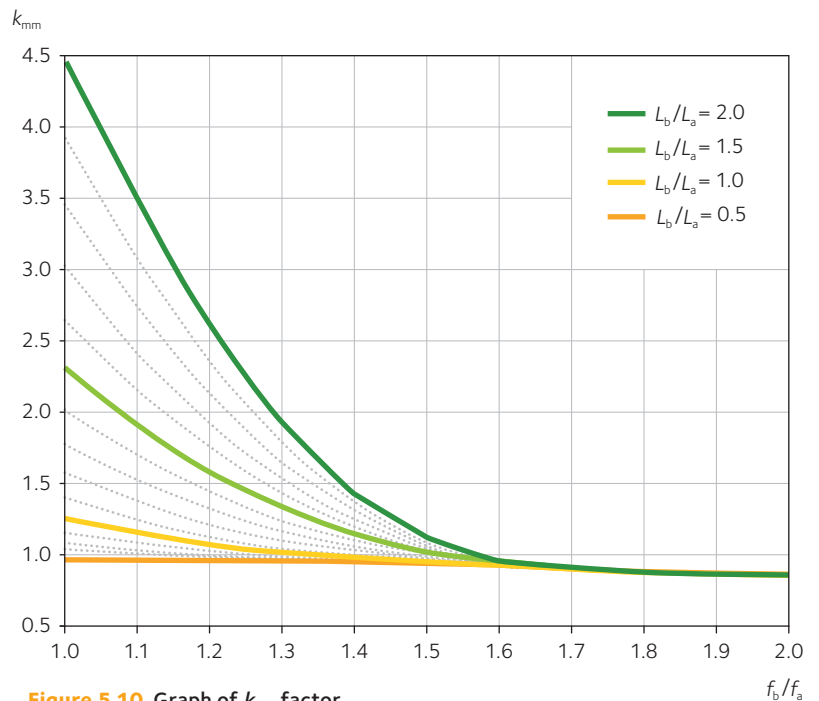

Figure 5.10 Graph of k_{mm} factor

Calculation of the transient response:

$$v_{\text{rms}} = v_{\text{tot,peak}} (0.65 - 0.01 f_1) (1.22 - 11\zeta) \eta \quad 5.32$$

$$v_{\text{tot,peak}} = k_{\text{mult}} v_{1,\text{peak}} \quad 5.33$$

$$v_{1,\text{peak}} = \frac{I_{\text{eff},1}}{m} \quad 5.34$$

where:

$I_{\text{eff},1}$ is the modal impulse of the first mode.

ζ is the damping ratio.

$\eta = 1.35 - 0.4 k_{\text{imp}}$, when $1.0 \leq k_{\text{imp}} \leq 1.7$ else $\eta = 0.67$.

k_{mult} is the factor that accounts for the contribution of higher modes that is given by:

$$k_{\text{mult}} = \max \left\{ \begin{array}{l} 0.48 \left(\frac{B}{L} \right) \left(\frac{(EI)_L}{(EI)_T} \right)^{0.25} \\ 1.0 \end{array} \right. \quad 5.35$$

The transient response factor is then calculated as follows for $R = 1$ ($v_{R=1}$) at the fundamental frequency, f_1 :

$$\text{If } f_1 < 8\text{Hz} \quad v_{R=1} = (5 \times 10^{-3}) / (2\pi f_1) \text{ m/s}$$

$$\text{If } f_1 > 8\text{Hz} \quad v_{R=1} = 1.0 \times 10^{-4} \text{ m/s}$$

$$R = \frac{v_{\text{RMS}}}{v_{R=1}} \quad 5.36$$

Calculation of the resonant response:

$$a_{\text{peak}} = \frac{0.4 k_{\text{mult}} \rho_{h,m} F_h}{2 \zeta m} \quad 5.37$$

Response factor can be calculated as follows:

$$R = \frac{a_{\text{peak}}}{0.0071 \text{ ms}^{-2}} \quad 5.38$$

In the above check, the harmonic force F_h should be calculated using the lowest harmonic that matches the natural frequency of the floor. For example, if the natural frequency of the floor is 6 Hz and range of walking frequencies is from 1 – 2.5 Hz, then the 3rd Harmonic of a 2 Hz walk (which has a frequency of 6 Hz) will cause the most unfavourable response; this will be worse than the 4th harmonic of a 1.5 Hz walk (which also has a frequency of 6 Hz), since lower harmonics have more energy.

5.4 Fire safety

The structural and fire safety design of CLT floors needs to be carefully coordinated. A combustible material demands a different approach to fire safety because aspects such as the increased fire load and the risk of collapse if it continues burning also need to be considered. While in some cases it may be possible to leave the CLT visually exposed, in many cases it will be necessary for the CLT to be fully encapsulated for fire safety. This is discussed more in *Chapter 7*, page 98.

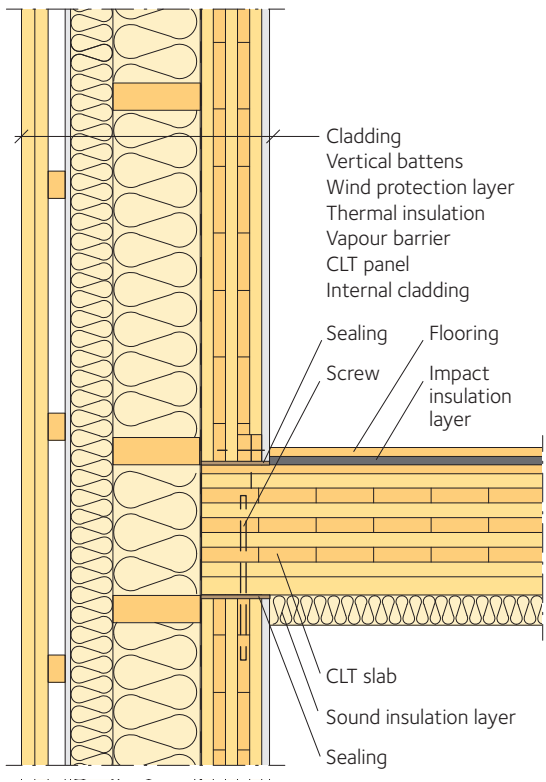

Figure 5.11 External wall of a single family house

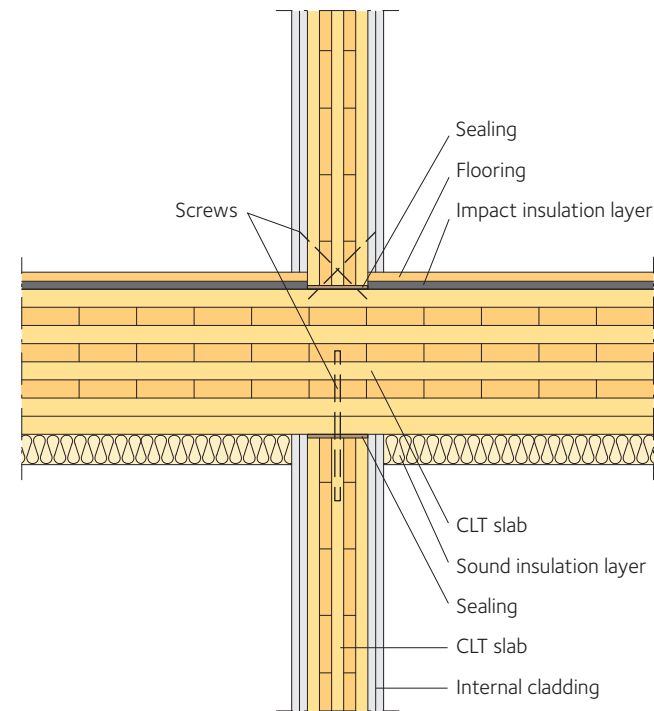

Figure 5.12 Internal wall of a single family house

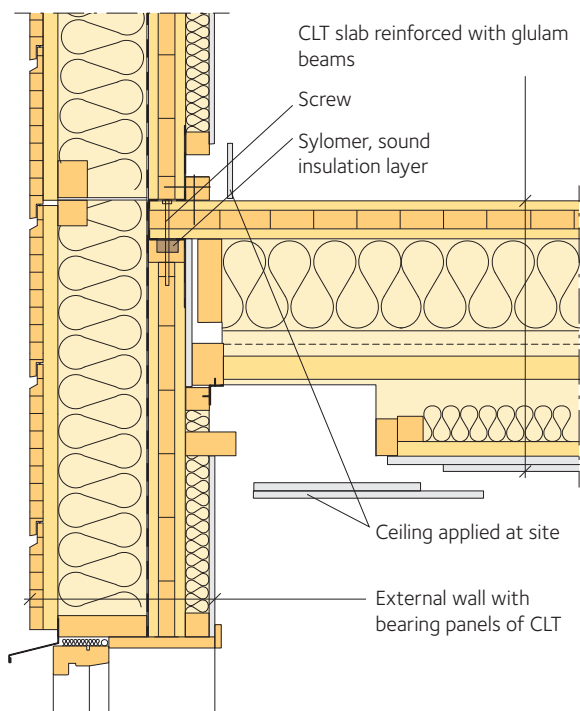

Figure 5.13 External wall with acoustic separation floor-to-floor
Note that the detail shown may not be suitable to meet fire regulations for residential buildings in multiple occupation in the UK.

5.5 Acoustic performance

As well as fire safety, the acoustic performance will often determine the floor build up. For residential buildings in multiple occupation, where there are obviously tighter acoustic requirements than a single family house, most of the CLT will usually need to be covered with additional layers to achieve suitable acoustic separation. Timber floors therefore demand a multi-disciplinary approach to design, which includes not only structural but also acoustic and fire safety aspects. The acoustic design of CLT floors is discussed in *Chapter 8, page 112*, together with examples of suitable build-ups.

5.6 Details

The structure of a building consists of several connections between walls and beams, walls and walls or walls and ceilings. Depending on the fire and acoustic requirements, and the structural requirements, the design may vary. Careful coordination is therefore required. For example, *figure 5.14, page 83*, helps acoustic separation but implies a break in the structural floor diaphragm. *Figures 5.11 – 5.15* show several generic solutions. The fire and acoustic performance of these details are discussed in *Chapters 7, page 98*, and *8, page 112*, respectively.

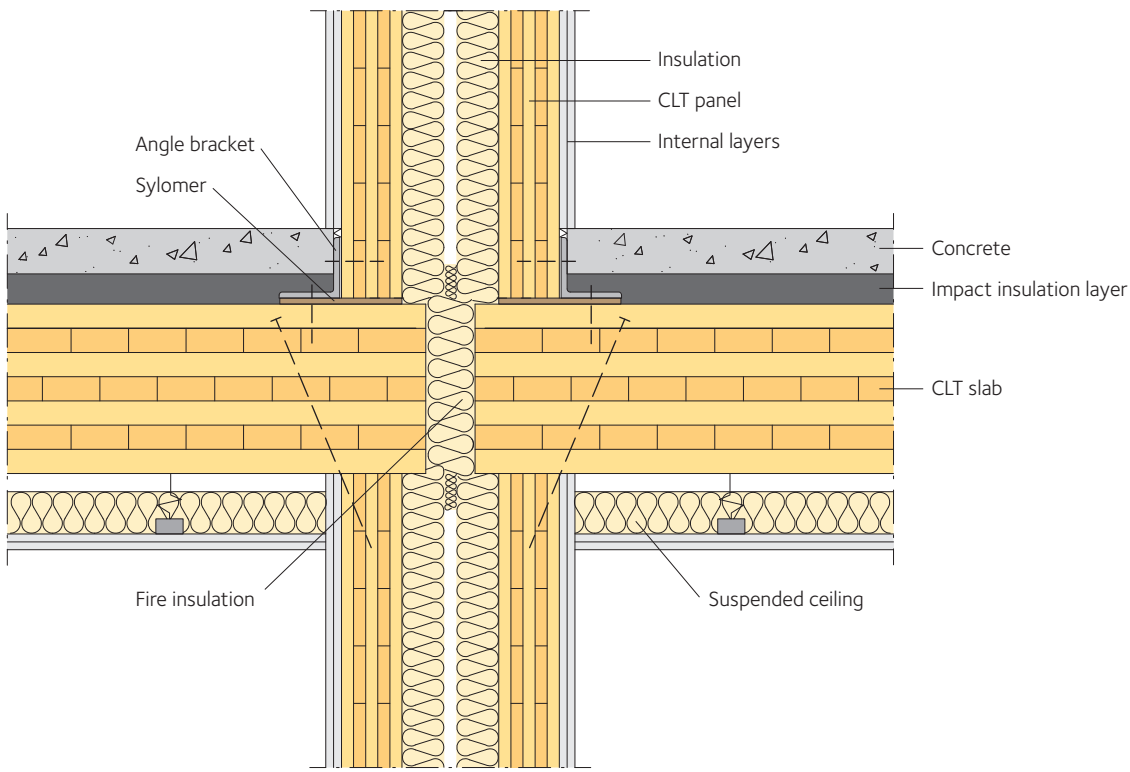

Figure 5.14 Internal party with acoustic separation floor-to-floor and wall-to-wall

Note that the detail shown may not be suitable to meet fire regulations for buildings in multiple occupation in the UK.

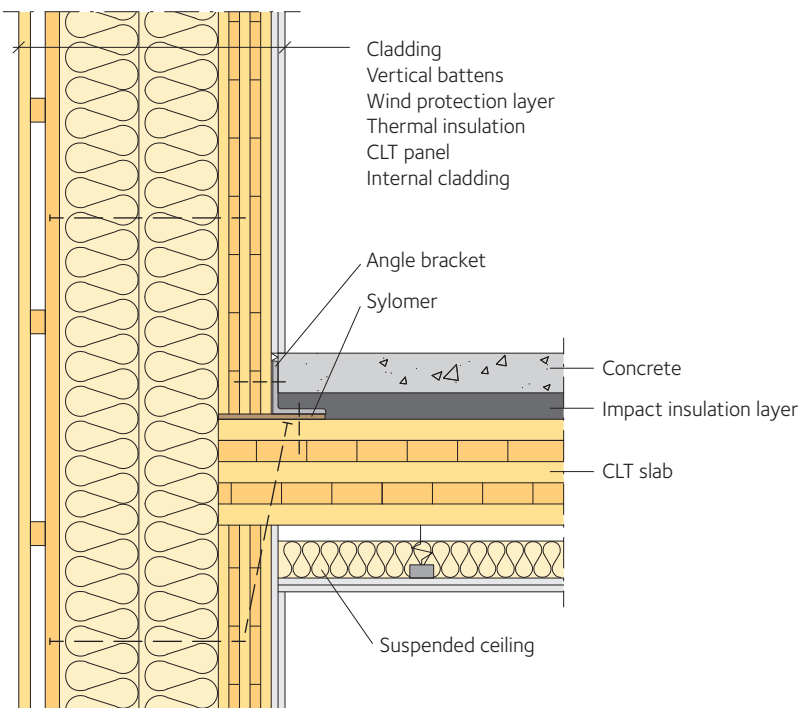

Figure 5.15 External wall with acoustic separation floor-to-floor

Note that the detail shown may not be suitable to meet fire regulations for buildings in multiple occupation in the UK.



Staircase, Orsman Road apartments, London, England.

5.7 Example

5.7.1 ULS design of floor

Simply supported floor of length $L = 4.5$ m and width 5 m, in service class 1.

Loads:

Self-weight $g_k = 1.1$ kN/m²

Imposed load $q_k = 2.0$ kN/m²

The floor comprises a 5-layer CLT panel with a thickness of $40 + 20 + 40 + 20 + 40 = 160$ mm and with all the layers of boards in strength class C24. Service class 1.

For CLT with boards only of strength class C24, the following applies in line with *table 2.4, page 31*:

$$E_{0,x,0.05} = 7,400 \text{ MPa}$$

$$E_{0,x,0.05} = 7,400 \text{ MPa}$$

$$E_{0,x,\text{mean}} = 11,000 \text{ MPa}$$

$$G_{9090,x,\text{lay,mean}} = 50 \text{ MPa}$$

$$G_{090,x,\text{lay,mean}} = 690 \text{ MPa}$$

$$f_{m,k} = 24 \text{ MPa}$$

$$f_{v,90,k} = 1.2 \text{ MPa}$$

With $\gamma_m = 1.25$ and $k_{\text{mod}} = 0.8$ (imposed load is leading action = medium load duration) the design strengths become:

$$f_{m,d} = \frac{k_{\text{mod}} \times f_{m,k}}{\gamma_M} = \frac{0.8 \times 24}{1.25} = 15.36 \text{ MPa}$$

$$f_{v,90,d} = \frac{k_{\text{mod}} \times f_{v,90,k}}{\gamma_m} = \frac{0.8 \times 1.2}{1.25} = 0.77 \text{ MPa}$$

Calculations:

Cross-sectional properties can be calculated using the methods given in *Chapter 3, page 34*.

Design load combination for vertical load for a strip $b_x = 1.0$ m:

$$q_d = \gamma_G g_k + \gamma_Q q_k = 1.35 \times 1.1 + 1.5 \times 2 = 4.48 \text{ kN/m}$$

Moment

Design moment for a single-span beam of length $L = 4.5$ m:

$$M_d = \frac{q_d L^2}{8} = \frac{4.48 \times 4.5^2}{8} = 11.34 \text{ kNm}$$

$$\sigma_{m,\text{out},d} = \frac{M_{\text{out},Ed}}{W_{\text{out}}} = \frac{11.34 \times 10^6}{3800 \times 10^3} = 2.98 \leq 15.36 = f_{m,d}$$

Shear force

Design shear force:

$$V_d = \frac{q_d L}{2} = \frac{4.48 \times 4.5}{2} = 10.08 \text{ kN}$$

$$\tau_{\text{out,d,gross}} = \frac{1.5 V_{\text{Ed,out}}}{A_{\text{gross,out,V}}} \leq f_{v,90,d}$$

$$\tau_{\text{out,d,gross}} = \frac{1.5 \times 10.08 \times 10^3}{1600 \times 10^2} = 0.0945 \text{ MPa} \leq 0.77 \text{ MPa}$$

Deformations

$$\frac{L}{300} = \frac{4500}{300} = 15 \text{ mm}$$

$$w_{g,k} = \frac{5g_k l^4}{384(EI)_{\text{eff,out}}} + \frac{g_k l^2}{8\kappa G_0 A_{\text{net}}} = \frac{5 \times 1.1 \times 4500^4}{384 \times 30400 \times 10^4 \times 11000} + \frac{1.1 \times 4500^2}{8 \times 0.2 \times 690 \times 1200 \times 10^2} =$$

$$= 1.76 \text{ mm} + 0.17 \text{ mm} = 1.93 \text{ mm}$$

$$w_{q,k} = \frac{5q_k l^4}{384(EI)_{\text{eff,out}}} + \frac{q_k l^2}{8\kappa G_0 A_{\text{net}}} = \frac{5 \times 2 \times 4500^4}{384 \times 30400 \times 10^4 \times 11000} + \frac{2 \times 4500^2}{8 \times 0.2 \times 690 \times 1200 \times 10^2} =$$

$$= 3.19 \text{ mm} + 0.31 \text{ mm} = 3.5 \text{ mm}$$

Short-term deformation:

$$w_{\text{inst}} = w_{g,k} + w_{q,k} = 1.93 + 3.5 = 5.43 \text{ mm}$$

Final deformation because of creep on quasi-permanent action:

$$k_{\text{def}} = 0.85$$

for service class 1, in line with *table 3.3, page 45*.

$$w_{\text{fin}} = w_{\text{inst}} + w_{\text{creep}}$$

$$w_{\text{fin,g}} = w_{g,k} (1 + k_{\text{def}}) = 1.93 (1 + 0.85) = 3.57$$

$$w_{\text{fin,q}} = w_{q,k} (1 + \Psi_2 k_{\text{def}}) = 3.5 (1 + 0.3 \times 0.85) = 4.4$$

$$w_{\text{fin}} = w_{\text{fin,g}} + w_{\text{fin,q}} = 3.57 + 4.4 = 8 \text{ mm}$$

Walls

- 6.1 Overview 86
 - 6.1.1 Load-bearing external and internal walls 86
 - 6.1.2 Non-load-bearing internal walls 88
- 6.2 Structural design 88
 - 6.2.1 CLT and load-bearing capacity 88
 - 6.2.2 Methods of sizing elements 88
- 6.3 CLT shear walls 88
 - 6.3.1 Deformation and flexibility of individual and segmented CLT walls 88
 - 6.3.2 Overall lateral stability 90
- 6.4 Fire safety 93
- 6.5 Acoustic performance 93
- 6.6 Wall build-ups 93
- 6.7 Connection details 93
 - 6.7.1 Connection to the foundation 93
 - 6.7.2 Wall-to-floor connection 94
 - 6.7.3 Wall-to-roof connection 95
 - 6.7.4 Window details 95
 - 6.7.5 External corners 95
- 6.8 Example calculations 96
 - 6.8.1 Wall panel with openings – control of buckling 96

Walls are often part of a building's load-bearing structure, but in many instances their task is only protection and separation. CLT walls are able to combine several functions, including structure and sometimes finishes.

A CLT wall can be anything from a single panel to multiple smaller panels joined together. The size of an individual panel is limited partly by the practicalities of handling and the transport and craning options, but also by manufacturing capability. CLT walls can have a thickness of about 60 mm to 300 mm, which means that it is possible to manufacture long, storey-height wall panels with considerable load-bearing capacity. To reduce the risk of large components becoming weak laterally, they can be stiffened with external timbers. In terms of transport, the size of the components should generally be less than 3.6 m × 12 m, although in exceptional cases panels up to about 4 m tall and 16 – 20 m long can be transported on a trailer or using specialist transport. Storey-height walls of CLT panels normally weigh between 25 kg/m² and 130 kg/m² depending on the design. Walls are usually delivered with fitted lifting straps.

The wall may be made entirely from CLT or supplemented with insulation, cladding, windows and doors. In most cases, external walls are supplemented with further layers of insulation and cladding. The smooth surface of the CLT panel provides a good underlay for other layers.

Internal walls may be load-bearing or non-load-bearing. Walls separating apartments have to meet particular requirements concerning sound insulation and fire resistance, while bathroom walls also have to be designed to avoid water damage.

6.1 Overview

6.1.1 Load-bearing external and internal walls

The main tasks of load-bearing external walls, as well as forming the building envelope, are to carry vertical loads from the floor structures above and to resist out-of-plane wind loads. In cases where the walls are involved in stabilising the structural frame, they must also resist in-plane horizontal loads. If the CLT is left visually exposed (for example in a single-family house) the thickness of the CLT panel will often be governed by fire and will rarely be less than 70 mm even for a small house.

Finishes can be prefabricated or applied on site. CLT panels are commonly supplemented with an external breather membrane, external insulation and an internal vapour barrier. Internally, the CLT panel can be fitted directly with interior plasterboard or additional insulation. A less insulated, or uninsulated, gap on the inside may be preferable as it can provide space for wiring etc. If the fire safety requirements allow, it may be possible to leave the CLT panel exposed on the interior. Externally, the breather



Cross-section through a load-bearing CLT wall. CLT panels ready for finishing.

CLT panels ready for additional layers.

membrane is spaced off the CLT panel with studs or spacing battens, usually in the same zone as the insulation.

Load-bearing internal walls usually have just one main task, to carry vertical loads down to the underlying structure or to the foundations. In contrast to an external wall, a load-bearing internal wall often needs to resist fire from both sides at the same time, if the wall is located within the same fire compartment. Whether or not an internal wall can be left visually exposed will depend on fire and acoustic requirements.

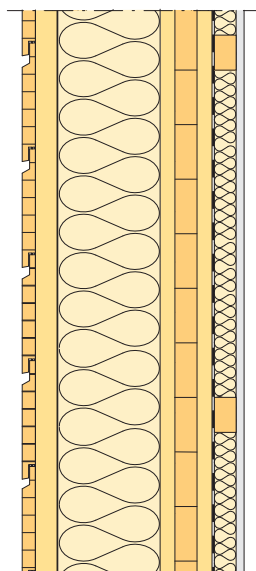

From outside in:
 25 mm horizontal glulam cladding
 34 × 70 mm vertical battens
 Breather membrane
 Vertical studs and insulation
 80 mm CLT panel
 Vapour barrier
 Horizontal studs and insulation
 Internal cladding

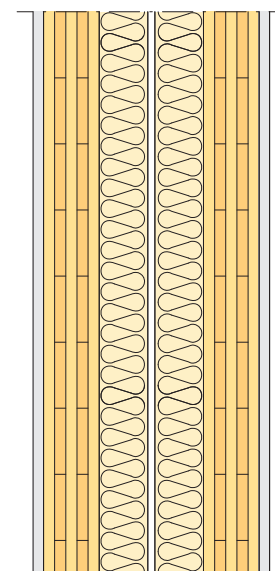

Plasterboard
 100 mm CLT panel
 70 mm insulation
 10 mm air gap
 70 mm insulation
 100 mm CLT panel
 Plasterboard

Figure 6.1 Example of external wall build-up for a single family house. Note that in cold, damp climates such as the UK, it is particularly important to ensure continuity of the external breather membrane and the internal vapour barrier, so that the timber stays dry. The external breather membrane is needed to protect the timber from rain; good workmanship is particularly important around windows. The internal vapour barrier is needed to ensure that internal moist air does not come into contact with the cold outer zones of the wall leading to condensation within the wall build-up; if the CLT is thick enough (typically at least 5 layers thick) and if the CLT panels are tightly fixed/sealed together, then the CLT itself can often act as a sufficient vapour barrier. See also section 9.1, page 131.

Figure 6.2 Example of partition wall between apartments using a load-bearing CLT panel. The twin wall construction is used for acoustic separation.



Assembly of CLT walls.

6.1.2 Non-load-bearing internal walls

Internal walls are designed differently, depending on their type. In most cases, the desire is for a wall in its simplest form, which generally means a lightweight stud wall. CLT can be chosen for internal walls that are not load-bearing, but where better separation is required. Internal party walls must meet particular requirements concerning sound insulation and fire resistance, while bathroom walls also have to be designed so that they meet tough standards of water resistance. CLT panels are also used for internal walls in buildings where high strength and impact resistance are required, such as in sports halls.

6.2 Structural design

6.2.1 CLT and load-bearing capacity

CLT panels that are affected by vertical loads and moments, for example from eccentric loads from floor structures or wind load, are to be designed as bending and compression members. In most cases, the deformation occurs in the structure's weak direction, and so the rules for bending and compression columns can be applied. For slender CLT panels, buckling is usually critical for the wall's load-bearing capacity. Bearing pressure under the wall must also be checked.

6.2.2 Methods of sizing elements

Designing with the help of available diagrams or tables

Since most CLT manufacturers provide design tables and graphs for their products, these tools can be very helpful at concept stage. When using these tools, it is important to note the conditions for which the stated values apply. For example, it is important to check the load duration, service class, and support system that have been assumed, and whether eccentricity of load has been accounted for.

Designing through calculation

This is possible using principles presented in *Chapter 3, page 34*, and also using FE as appropriate.

6.3 CLT shear walls

6.3.1 Deformation and flexibility of individual and segmented CLT walls

CLT panels may be used as the building's main stability system. In a CLT building (as with any other building), loads are normally transferred from façade/outer walls to the floor diaphragm and then from the floor to the stability walls. A wall may comprise of

- Multiple wall panels that are connected with vertical joints.
- Multiple panels with horizontal joints.
- Multiple floor panels with horizontal and vertical joints.

Deformation modes of single panels

Prior to understanding deformation of multi-panel walls it is necessary to first understand the deformation behaviour of individual panels.

An individual wall panel can deform in the following four modes. The total deformation will be the sum of the deformation in these four modes:

1. Bending

The deflection of a panel in bending due to force F is given by:

$$\delta_{\text{Bending}} = \frac{Fh^3}{E_0 I_{\text{net,in}}}$$

2. Shear

The deflection of the panel in shear is given by:

$$\delta_{\text{Shear}} = \frac{Fh}{G_{\text{in-plane}} A_{\text{tot}}}$$

3. Sliding

The sliding deflection is given by:

$$\delta_{\text{Sliding}} = \frac{F}{n_{\text{eff}} k_s}$$

where:

- n_{eff} is the effective number of anchors.
- k_s is the stiffness of shear anchors.

4. Rocking

The rocking deflection is given by:

$$\delta_{\text{Rocking}} = \frac{F}{K_{\text{Rocking}}}$$

$$K_{\text{Rocking}} = K_{\text{tie-down connector}} \times \left(\frac{L_{\text{eff}}}{h} \right)^2$$

where:

- $K_{\text{tie-down connector}}$ is the axial stiffness of tie down connector.
- L_{eff} is the effective lever arm. At concept stage $0.7 \times$ the wall diameter can be taken.

Walls with only one panel per floor

The possible deformation modes of an individual wall that is one panel wide is shown below. The total deformation will be the sum of all these deformation modes.

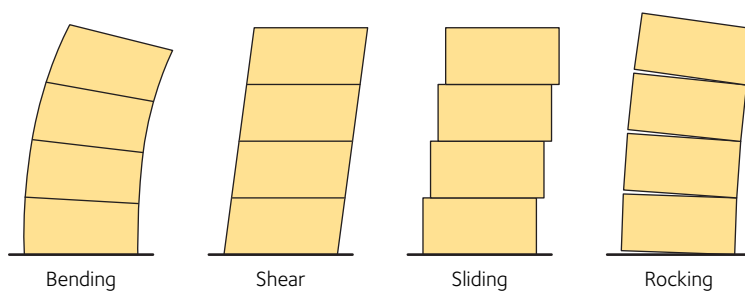

Figure 6.5 Deformation modes of multi-storey wall with single panel per storey

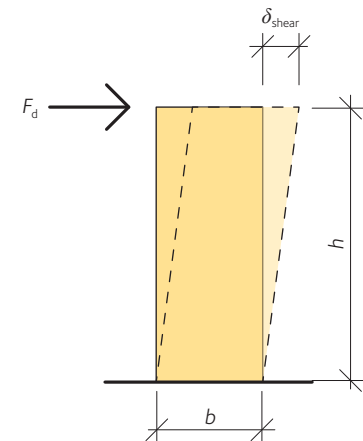

Figure 6.3 Shear deformation mode of a single panel

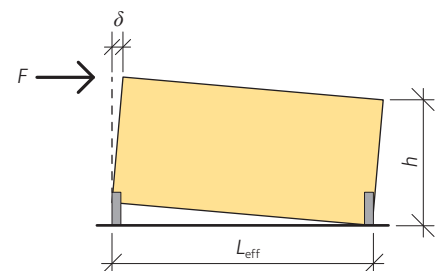

Figure 6.4 Rocking deformation mode of a single panel

Rocking at a given level will only occur if the self-weight of the wall panels above and surcharge loads from the floors are insufficient to prevent uplift of the windward side due to moment induced from the lateral load acting above the level being considered.

The total deflection of a single wall system is given by:

$$\delta_{\text{Tot}} = \delta_{\text{Bending}} + \delta_{\text{shear}} + \delta_{\text{Sliding}} + \delta_{\text{Rocking}}$$

Sliding and rocking modes occur due to deformation in the connections. Normally the deformation due to sliding and rocking (when it occurs) is far more significant than the deformation due to bending and shearing of the CLT panels. Since sliding and rocking modes depend entirely on connection deformation, it is difficult to predict the deformation due to these modes.

In low-rise buildings, where there is sufficient surcharge and self-weight from floors, uplift at the connections will not occur and hence the rocking mode will be suppressed. Further, depending on the lateral force applied and the geometry of the walls, surcharge load may lead to shear between floors being transferred in friction. In such a case the total deformation of the wall will be due to the shear and bending modes only. In some buildings rocking and sliding may only occur at lower floors where shear and bending moments are high, and not at floors higher up the building.

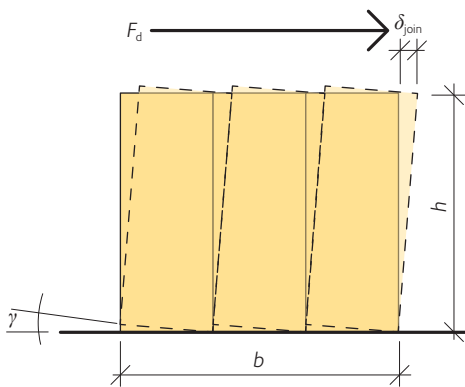

Figure 6.6 Deformation mode of single storey multi-panel wall due to rocking of individual panel

Walls with multiple panels per floor

In some instances multi-panel CLT walls may also have several panels within a floor, as shown in *figure 6.6*. In such cases the additional deformation mode shown below would occur. Where this is the case, the behaviour of the stability wall becomes even more complex. Considering a multi-storey stability wall as a cantilever, the effect of this mode can be thought of as partial interaction along multiple longitudinal lines along the length of the cantilever. The deflection due to this mode depends on the rocking (and therefore on the surcharge load from above and the stiffness of the tie-down connectors) as well as on the stiffness of the connections along the vertical joints between CLT panels.

As it is clear that the behaviour of the CLT panels is highly complex for the reasons mentioned above, accurately predicting the deformation of a single multi-storey wall requires an FE model with the connection stiffnesses accurately modelled. Even then, since stiffnesses of timber connections have high variability, the deformation of a given wall is uncertain. Ways to deal with this are discussed further below.

6.3.2 Overall lateral stability

A building up to about 10 storeys may be stabilised against horizontal loads by using walls and floor structures as stiff, force-absorbing panels.

The load path for wind load on the façade/outer walls of a building is as follows:

Façade → Floor diaphragms → Shear walls → Foundations

The building must be checked for both an overturning moment and horizontal sliding at each level. One way that overturning may be verified is to check that the line of action of the total load is within the middle third of the length of the wall at each level (an example

for the ground floor level is shown in *figure 6.7*). If this is the case, then there will be no net uplift at the level being checked. Two load cases should be checked:

1. Factored vertical and horizontal load:
Conservative for checking peak compression.
2. Reduced vertical load (0.9) and factored horizontal load:
Conservative for checking whether uplift does occur.

The eccentricity of the line of action of the force at a given level is calculated by dividing moment in the wall by the axial force.

Generally (but not always) it is the interface between the foundation and the wall at ground level that governs. If this is the case, then the shear wall is usually treated as a single unit and the connection found to be required at ground level (through calculation) may be repeated at levels above ground level, provided that the wall structure is the same on all floors.

In general, since CLT floors are one-way spanning, shear walls that are parallel to the spanning direction of the floor, and therefore not supporting the load from the floor, are more likely to have net uplift. If the self-weight above a given level doesn't provide sufficient resistance to overturning then tension anchors will be required.

Preventing sliding is usually not a major problem; shear anchors are generally installed to transfer horizontal reactions between upper floors and between ground floor wall and the foundation at ground level. Foundations should then be designed as appropriate.

Load-paths in indeterminate stability systems

Loads will tend to follow the stiffest load-path; hence the distribution of the loads in indeterminate stability systems depends on the relative stiffness of the load-paths involved. In a building constructed out of a more common material such as concrete, the floor can be assumed to be a stiff diaphragm and wall stiffnesses can be quantified, making it relatively straightforward to calculate distribution of forces by hand calculation or FE analysis.

In timber stability systems, most of the overall flexibility is not due to the flexibility of the material but of the connections. Since the stiffness of timber connections is highly variable, it is difficult to know with certainty the overall stiffness of stability walls, diaphragms and their associated load-paths. In addition, timber diaphragms are also not fully rigid, which makes the stiffness of load-paths and therefore load distribution even more uncertain.

Therefore, suitable sensitivity of internal load distribution to connections stiffness variability should be carried out. **The simpler alternative is to design the lateral stability system to be determinate, for example with just two shear walls in one direction and one shear wall in the other direction.**

Floor diaphragms

The horizontal forces that walls and floor structures must resist when stabilising multi-storey buildings are shown in *figure 6.8*. The wind load on a wall must be carried to the floor at the top and bottom of this wall by vertical spanning of the wall. If the wind load is constant across the whole height of the building, all the floor structures (except the floor structures of the top floor and ground floor) are subject to the same forces.

CLT diaphragms are more flexible than concrete diaphragms and therefore serviceability checks should also be undertaken.

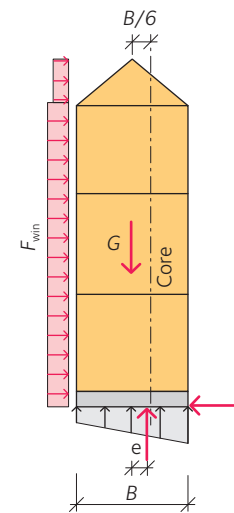

Figure 6.7 Checking for overturning

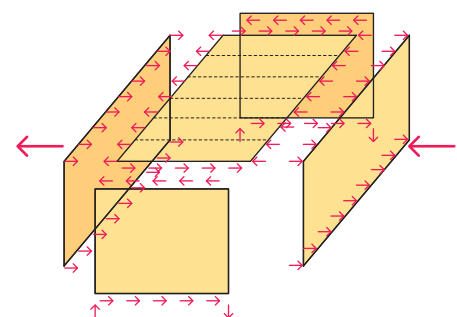

Figure 6.8 Load-path diagram for transfer of wind load from façade wall to shear walls via floor diaphragms

Horizontal shear connection between wall and floor structure

Some form of mechanical connection is usually required to achieve sufficient shear resistance between the stabilising wall panels and the floor slabs.

Anchoring of walls using tie-down connectors

Horizontal loads that are transferred to stabilising walls will cause both horizontal and vertical reaction forces in the walls due to the overturning moment. The wall can be prevented from lifting by loading the wall or by attaching it to the level beneath with an anchor. The wall can also be prevented from lifting by connecting it to return walls, although this would require very detailed checks of the following:

- calculations to check for flexibility of the vertical joints between the two walls and resulting partial interaction.
- resulting changes to relative stiffness of overall load paths and resulting effects on internal force distribution.
- whether the return walls need anchors.

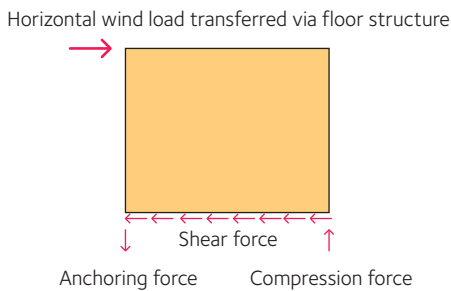

Figure 6.9 Force equilibrium for shear wall panel

The design of the anchor for a wall panel thus depends on the size of the horizontal force that the wall has to resist, the weight of the structure above, the wall panel’s length-to-height ratio, the flexibility of vertical joints between panels, and the wall’s connection to return walls. Standard industry practice is to provide anchors at the edges of walls as shown below. It should be noted that this arrangement of anchors is not compatible with an elastic distribution of bending stresses calculated using standard bending theory. If this type of anchorage arrangement is used, then the CLT panel will have to be checked for the stress distribution that arises. This may be done by using hand calculation or FE.

An alternative is to provide anchors along the entire length of the wall. This arrangement of anchors is compatible with bending force/stress distribution calculated using standard elastic bending theory.

Walls with openings should ideally be constructed in separate pieces to avoid the risk of high vierendeel bending stresses around the opening. If walls with openings are constructed using a panel with cut-outs then:

- either they should be excluded from the lateral load path by designing the connectors at the top and base of the wall to not attract lateral load.
- or, if the wall is to be part of the lateral stability system, then vierendeel stresses in the lintels above and below the cut-outs should be checked. This will depend not just on the lateral force, wall and cut-out geometry, but also on the stiffness and strength of connections between the wall and adjacent walls and floors it is connected to. This may be done by hand calculation or using FE.

Progressive collapse

With buildings that have a load-bearing structure of CLT, it is usually not possible to design individual components for other constituent parts of the frame to resist accidental loads (e.g. an explosion). Instead an element removal approach is normally used in timber structures.

6.4 Fire safety

As with CLT slabs, the structural and fire safety design of CLT walls need to be carefully co-ordinated. A combustible material demands a different approach to fire safety because aspects such as the increased fire load and the risk of collapse if it continues burning also need to be considered. While in some cases it may be possible to leave the CLT visually exposed and rely on slow charring of the wood, in many cases it will be necessary for the CLT to be fully encapsulated for fire safety. This is discussed more in *Chapter 7, page 98*.

6.5 Acoustic performance

As well as fire safety, the acoustic performance will often determine the wall build-up. For residential buildings in multiple occupation, where there are obviously tighter acoustic requirements than for a single family house, most of the CLT will usually need to be covered with additional layers to achieve suitable acoustic separation. The best performance is achieved with twin walled construction, with two CLT panels separated by a layer of acoustic insulation, such as the detail shown in *figure 6.2, page 87*. The acoustic design of CLT walls is discussed in *Chapter 8, page 112*, together with examples of suitable build-ups.

6.6 Wall build-ups

The build-up of CLT walls depends on the thermal, acoustic and fire safety requirements, as well as on whether there is a need for a cavity for wiring. *Figures 6.1 and 6.2, page 87*, show typical external and internal wall build-ups. The fire and acoustic performance of various build-ups are discussed in *Chapters 7, page 98*, and *8, page 112*, respectively.

6.7 Connection details

6.7.1 Connection to the foundation

There are various ways to connect an external CLT wall to the foundation. Where the wall is assembled on-site (which is the usual situation in the UK), the CLT panel is delivered and then fitted with insulation, weatherproofing, façade cladding, windows and doors. Adding these additional layers on-site makes it easier to conceal the CLT fixings. One method of fixing a wall in place is to attach a sole plate to the foundations to serve as both a fixing and a guide rail for the wall. The CLT panel is then screwed from the inside into the sole plate fixed to the concrete slab, *see figure 6.10, page 94*. A waterproof strip must be placed on top of the sole plate to provide a good seal against the lower edge of the prefabricated wall. Although not shown in the figure, it is generally recommended that CLT ground floor walls are supported on an upstand to prevent water damage during construction.



External wall made of CLT.

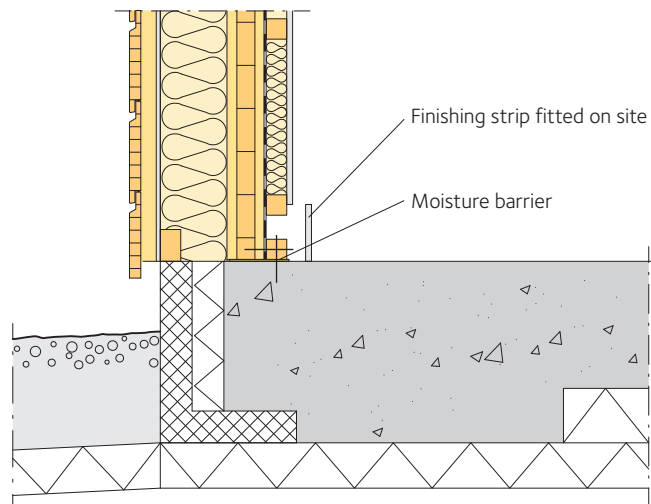

Figure 6.10 Connecting an external CLT wall to a concrete slab. Although not shown, it is generally recommended that CLT ground floor walls are supported on upstands to prevent water damage during construction.

The highest uplift and shear forces obviously tend to occur at the connection between the wall and the foundations. To meet the requirements concerning both load-bearing capacity and weatherproofing, it is important that the foundations are made with very small dimensional tolerances. Having very little unevenness in the foundations also makes the fitting of the mass timber components easier. For more information on fixings, see *Chapter 4, page 52*.

6.7.2 Wall-to-floor connection

The connection between a load-bearing wall and a floor structure has many functions: vertical and horizontal load transfer, weatherproofing and insulation, fire safety and acoustic performance. There are, in principle, two ways to connect the floor to the wall: directly supported and suspended.

When the slab is directly supported, see *figure 6.11*, it sits directly on the wall below, in what is termed ‘platform frame’ construction. The main advantages of this are ease of construction and the fact that the vertical load comes down centrally on the load-bearing wall. A flanking transmission strip is often placed between the floor and the wall, taking account of the bearing pressure, to improve the acoustic performance. The floor slab is fixed to the wall with an angle bracket or wood screws. Additional finishes are usually required for fire and acoustics.

Depending on the acoustic requirements, the top of the floor structure in a bathroom may be finished with gypsum flooring, waterproofing and tiles/carpet, see *Chapter 8, page 112*. In other rooms, the floor may be finished with carpet or wood flooring.

With a suspended floor, the connection involves placing the floor structure between the load-bearing walls. The floor is suspended on specially designed hangers or on a support beam fixed along the wall.

The benefit of using suspended floor structures is that flanking transmission strips of lower density and load-bearing capacity can be used, which saves money. For taller buildings in particular, it can be difficult to find flanking transmission strips with enough load-bearing capacity. Another advantage compared to platform frame for taller buildings is that there is less wood subject to large vertical loads perpendicular to the grain.

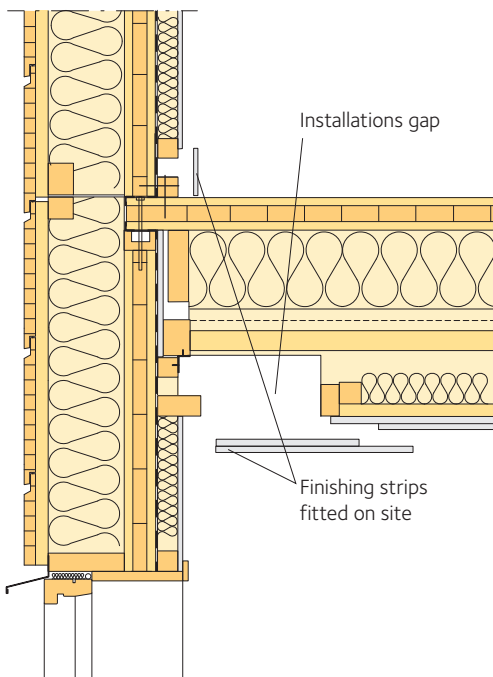

Figure 6.11 Floor slab directly supported on the external wall in what is termed ‘platform frame’ construction. This is the usual method used in the UK.

6.7.3 Wall-to-roof connection

Roof members and CLT panels can be connected using angle brackets, truss hangers or by skew-screwing directly into the CLT panels. The bearing pressure between the roof members and the CLT panel can be relatively large, since the wall panel and roof joists or trussed rafters are both relatively thin. To distribute the bearing pressure, the roof truss can have glued and nailed wooden cover plates added.

Waterproofing and thermal insulation are achieved by continuing the wall structure up into the roof, with external moisture protection provided by the external cladding, air gap and breather membrane. Internally, the wall's vapour barrier is connected to the roof vapour barrier.

6.7.4 Window details

There are two main ways of incorporating windows: mounting them directly in the plane of the CLT panel or attaching an external frame or angle bracket to the CLT panel to support the window. Careful detailing and workmanship of the breather membrane and vapour barrier round the window are particularly important to ensure the timber is protected from both rain and condensation.

6.7.5 External corners

There are many ways of detailing external corners between two walls (*figure 6.15, page 96*). Additional studs and insulation can be added on-site or prefabricated together with the load-bearing CLT panel. The breather membrane is screwed or clamped into place against the studs.

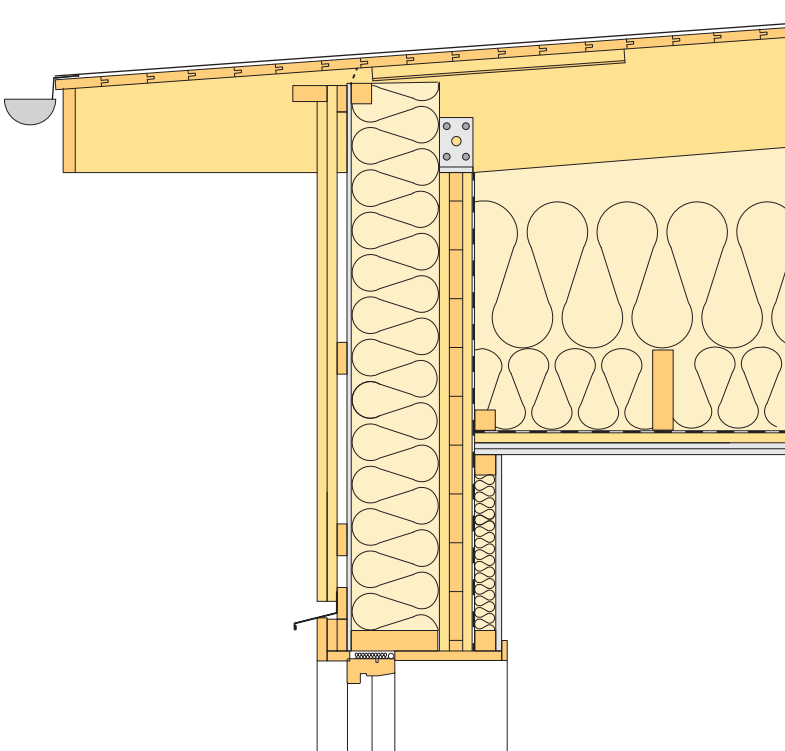

Figure 6.12 Wall-to-roof connection

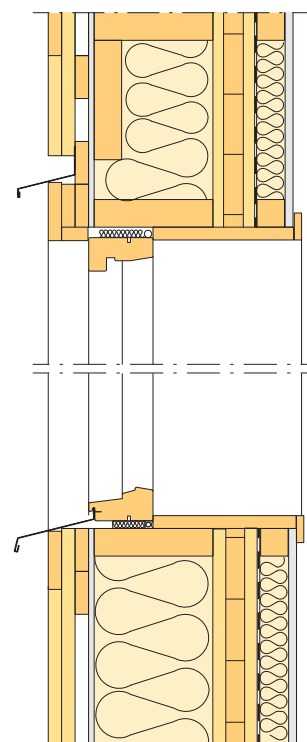

Figure 6.13 Window detail

6.8 Example calculations

6.8.1 Wall panel with openings – control of buckling

Background

A vertically loaded external wall on the ground floor of a two-storey building has a height $l_{\text{eff}} = 2.95$ m. The wall has two openings with dimensions as shown in figure 6.14. This example is for the check of the central post between the two windows. A similar check would also need to be carried out for the posts at the edges of the panel (although in this case, by inspection, they do not govern).

The design load from the roof, the wall and the floor above the wall is $F_d = 30$ kN/m (applied with no eccentricity). The design wind pressure on the wall is $q_d = 2.4$ kN/m² (this is high, but the example is for illustrative purposes only). The wall comprises a three-layer panel of CLT, thickness $3 \times 30 = 90$ mm, with all the layers of boards meeting strength class C24. Service class 1.

For CLT with boards only of strength class C24, the following applies:

$$\begin{aligned} E_{0,x,0.05} &= 7,400 \text{ MPa} \\ E_{0,x,\text{mean}} &= 11,000 \text{ MPa} \\ G_{9090,x,\text{lay,mean}} &= 50 \text{ MPa} \\ G_{090,x,\text{lay,mean}} &= 690 \text{ MPa} \\ f_{m,k} &= 24 \text{ MPa} \\ f_{c,0,k} &= 21 \text{ MPa} \end{aligned}$$

With $\gamma_M = 1.25$, and $k_{\text{mod}} = 1.1$ assuming wind loading is an instantaneous load, the design strengths are:

$$f_{m,d} = \frac{k_{\text{mod}} \cdot f_{m,k}}{\gamma_M} = \frac{1.1 \times 24}{1.25} = 21 \text{ N/mm}^2$$

$$f_{c,0,d} = \frac{k_{\text{mod}} \cdot f_{c,0,k}}{\gamma_M} = \frac{1.1 \times 21}{1.25} = 18.5 \text{ N/mm}^2$$

Calculation of loading

Axial loading due to load from above on middle post:

$$N_{\text{Ed,S}} = 30(0.8 + 1.07) = 56.1$$

Axial load due to self-weight of the panel attributed to the middle post may be conservatively taken as:

$$N_{\text{Ed,G}} = 4.2 \left[(0.8 + 1.07) \times 2.95 \times 0.09 \right] \times 1.35 = 2.81 \text{ kN}$$

Total design axial load:

$$N_{\text{Ed}} = N_{\text{Ed,S}} + N_{\text{Ed,G}} = 2.81 + 56.1 = 58.9 \text{ kN}$$

Total lateral force per vertical linear metre on post:

$$w_{\text{Ed}} = q_{\text{Ed,S}} (0.8 + 1.07) = 2.4(0.8 + 1.07) = 4.5 \text{ kN/m}$$

Since we wish to simply read off section properties from the tables in Chapter 3, page 51, which are per linear metre of section, it is necessary to multiply N_{Ed} and w_{Ed} by $1/(\text{post width})$ to obtain loading per metre width.

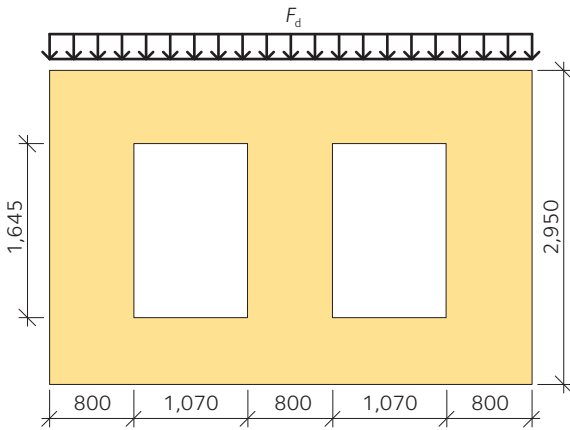

Figure 6.14 Example of wall with cut-outs (mm)

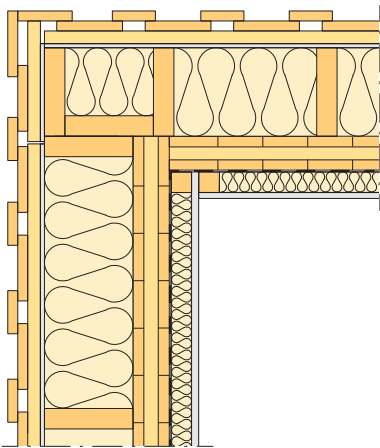

Figure 6.15 Design principle for corners of external walls, horizontal cross-section

Hence:

$$N_{\text{Ed},1} = \frac{58.9}{0.8} = 73.6 \text{ kN}$$

$$w_{\text{Ed},1} = \frac{4.5}{0.8} = 5.6 \text{ kN}$$

Moment per m length of post is given by:

$$M_{\text{out,Ed},1} = \frac{5.6 \times 2.95^2}{8} = 6.1 \text{ kNm}$$

Calculating k_c for a metre width of post

The effective design surcharge loading from above is:

$$N_{\text{cr},1} = \frac{E_{0.05} I_{y,\text{out}} \pi^2}{l_{\text{eff}}^2} = \frac{7400 \times 5850 \times 10^4 \times \pi^2}{2950^2} = 490956 \text{ N}$$

In the above, the effect of shear on critical buckling load has been neglected – this is generally reasonable.

$$\lambda_{\text{rel}} = \sqrt{\frac{A_{\text{net}} f_{c,0,k}}{N_{\text{cr}}}} = \sqrt{\frac{600 \times 10^2 \times 21}{490956}} = 1.6$$

$$\beta = 0.5(1 + \alpha_{\text{CLT}}(\lambda_{\text{rel}} - 0.3) + \lambda_{\text{rel}}^2) = 0.5[1 + 0.1(1.6 - 0.3) + 1.6^2] = 1.84$$

$$k_c = \frac{1}{\beta + \sqrt{\beta^2 - \lambda_{\text{rel}}^2}} = \frac{1}{1.84 + \sqrt{1.84^2 - 1.6^2}} = 0.36$$

The Dischinger factor ω (from *Chapter 3, page 45*) may be taken as = 0. Elastic bending stress (per m length of wall) is calculated as follows:

$$\sigma_{\text{m,out,d}} = \frac{M_{\text{out,Ed}}}{W_{\text{out}}} = \frac{6.1 \times 10^6}{1300 \times 10^3} = 4.69 \text{ N/mm}^2$$

Compressive stress in wall:

$$\sigma_{\text{c,in,net,d}} = \frac{N_{\text{Ed},1}}{A_{\text{net}}} = \frac{73.6 \times 10^3}{600 \times 10^2} = 1.23 \text{ N/mm}^2$$

Combined utilisation check:

$$\begin{aligned} \frac{\sigma_{\text{c,in,net,d}}}{k_c f_{c,0,d}} + \left(\frac{1 + \omega \frac{N_{\text{in,Ed},1}}{N_{\text{cr},1}}}{1 - \frac{N_{\text{in,Ed},1}}{N_{\text{cr},1}}} \right) \frac{\sigma_{\text{m,out,Ed}}}{f_{\text{m,d}}} &= \frac{1.23}{0.36 \times 18.5} + \left(\frac{1 + 0}{1 - \frac{74 \times 10^3}{491 \times 10^3}} \right) \frac{4.69}{21} = \\ &= 0.185 + 1.18(0.223) = 0.45 < 1 \end{aligned}$$

Note – shear has not been checked in this example, as this rarely governs the design.



Yoker apartments, Clyde, Scotland.

CLT and fire safety

- 7.1 Wood and fire safety 98
 - 7.1.1 Fire safety in buildings – three key phases 99
 - 7.1.2 Fire safety requirements in standards 101
- 7.2 Fire resistance of CLT 102
 - 7.2.1 Charring and influence of CLT adhesive properties 102
 - 7.2.2 Effective cross-section 103
 - 7.2.3 Design loads in event of fire 105
- 7.3 Design and details 107
- 7.4 Examples 108
 - 7.4.1 Unprotected floor structure 108
 - 7.4.2 Protected floor structure 109
 - 7.4.3 Unprotected wall panel 110
 - 7.4.4 Protected wall panel 111

Since the mid-1990s, there has been a transition in fire safety regulations from prescriptive, material-dependent requirements to functional requirements. This is due to extensive studies that have increased knowledge of fire safety behaviour in wooden materials and wooden structures. Wooden structures can now be designed for fire safety using new calculation models.

National fire safety regulations in Europe focus on health and safety of humans and prevention of loss of life. Loss of property has usually had a lower priority. Since most casualties in fires occur in the early stages of a fire and are caused by burning movable items like furniture and textiles rather than fire in the actual building elements, the risk for loss of life does not significantly differ between buildings with structural elements made of different materials like wood, steel, or concrete.

Fire safety design of all structures, including non-combustible structures, needs to cover the two aspects of reaction to fire (or how the surface material ignites) and resistance to fire (or how fire can penetrate into the material). In addition, since wood is a combustible material, the fuel contribution to the fire from the wood structure needs to be considered, and whether the structure may be involved in the fire according to the fire safety plan of the building.

7.1 Wood and fire safety

If an exposed non-fire-retardant-treated wooden surface is subject to the effects of fire, it will ignite. The burning then continues inwards, but at a largely constant speed. The charring rate is slow since the char layer that forms provides thermal insulation and combats the heat flow from the source of the fire to the pyrolysis zone. The pyrolysis zone is subject to temperatures of between around 250 °C and 350 °C, when flammable gases are formed and then diffuse through the char layer until they encounter oxygen on the surface and begin to burn. A commonly accepted boundary forms between the char layer and the residual cross-section at 300 °C, *see figure 7.1, page 99*. The penetration of the burning is greater at wide splits and external corners. The wood's good properties in a fire are mainly because it "protects itself" via the char layer, but sometimes extra cladding is required to provide additional fireproofing.

The temperature in the unburned parts of a large-scale wooden structure remain largely unaffected even under prolonged exposure to fire due to the heat-insulating properties of wood and the cooling effect of evaporating moisture. The evaporating moisture will limit the temperature inside the material to the boiling point of water. The flux of steam from the interior of the wood can also be expected to cool the charring layer and further reduce the oxygen available for combustion.

Temperatures considerably higher than 100 °C only occur in a narrow zone around 10 – 15 mm deep immediately beneath the char layer. Both strength and stiffness are significantly lower in this intermediate layer than in the unaffected wood, as will be discussed below.

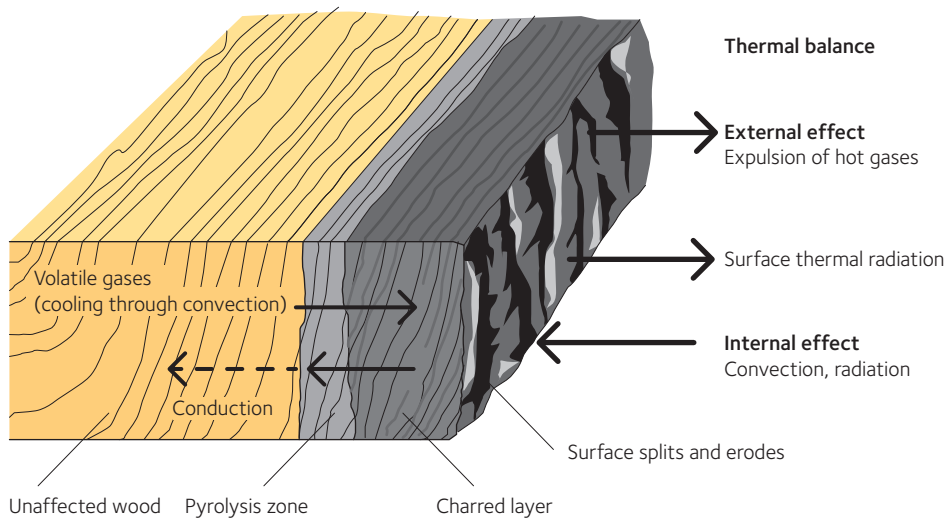

Figure 7.1 The phenomenon of the charring process

During a fire, a large proportion of the heat is transferred via mass transfer primarily through diffusion of fire gases. When these gases move inwards, the temperature rises until the wood begins to decompose and char, while the gases in the charred zone dampen the temperature rise in the glowing char layer. Just before the charred layer is a layer where the temperature is not high enough for charring to occur, but where the properties of the wood are nevertheless affected, with considerably reduced strength properties as result.

Standard SS-EN 1995-1-2 provides two alternative methods to calculate the effect of this “zero-strength layer”, where the reduced cross-section method is recommended to be used rather than to use the reduction coefficient for the mechanical properties of the material.

Methods for calculating the fire resistance of CLT are not included in the current version of EN 1995-1-2, but will appear in the next version. Such methods are included in the handbook *Fire Safe Use of Wood in Buildings – Global Design Guide, 2022*.

Metallic fasteners such as nails, wood screws, dowels and so on can contribute to a higher thermal flow into the wood and increase the burning rate.

7.1.1 Fire safety in buildings – three key phases

A typical development of a fire (based on conditions described in *section 2.1, page 24*), that is allowed to grow without the intervention of any active fire safety measures, can be defined by several consecutive main stages, as illustrated in *figure 7.2, page 100*. Initially, there is a pre-burning process eventually leading up to an ignition. Following the ignition, the fire starts to grow. The growth of the fire is mainly dependent on the availability and the characteristics of the fuel source. At one point, the temperatures or the radiation towards the floor in the room become so great that all available combustibles in the room ignite. This process is called flashover and is a rapid transition from a localized fire to a fully developed fire. During the fully developed fire stage the heat release rate is at its peak. The magnitude is dependent on the oxygen supply to the compartment. The fire at this stage is therefore described as a ventilation-controlled fire, in contrast to the pre-flashover conditions where the fire can be described as a fuel-controlled fire. The last stage of the fire is the decay stage,

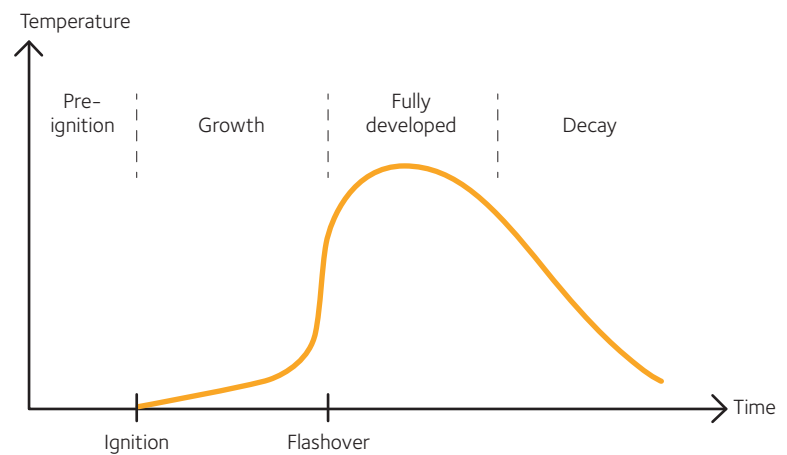

Figure 7.2 Typical stages of fire development

which is characterized by the combustibles in the compartment having been consumed by the fire to the point that the heat release rate cannot be sustained any further and, as a result, the fire intensity starts to decrease.

In all buildings, it is movable items (furniture, equipment, goods, etc.) that form the essential fire load at least for the early, developing phase of fire, when safety of life is most emphasized. The combustion process releases energy, gases and smoke. While gases and smoke are the main killers in a fire (approx. 80 percent of fire fatalities are due to toxic fire effluents), heat is the primary reason for damage to the structure of a building. As the mechanical and thermal properties of building materials change with increasing temperatures, knowledge of the time-temperature development during a fire in a building is most important for the structural fire analysis.

Fire load is defined as the energy (total heat release) of the combustible material present within the internal bounding surfaces of a room, compartment or building. Thus, it consists of the energy of the structural building elements and the energy of the contents. National regulations may also categorise building types according to expected fire load levels. In principle, fire protection by controlling the amount of fire load is possible, but in practice the difficulties depend on the energy of the contents of the building, which is mostly the main source of the fire load, and the magnitude of which is not controlled by regulations (only assumed categories may be used). Furthermore, it should be taken into account that energy from the structural elements is usually released much more slowly than energy from the contents of the building, because of the characteristics of the combustible building elements (e.g. charring of timber extends the duration of energy release to a long period), or because the building elements are protected for defined periods.

7.1.2 Fire safety requirements in standards

Primary focus: saving lives

To assure fire safety in buildings, a European system that includes performance classes, testing and calculation standards for fire performance was introduced in 1988 by the Construction Products Directive (CPD). The CPD was replaced by the Construction Products Regulation (CPR) in 2013. The main change is that the implementation of CPR is mandatory in all European countries. The European standards for fire safety in buildings are concerned mainly with harmonised methods for verification of the fire performance.

Six essential requirements were introduced in CPD and remain in CPR, one of which was fire safety. The requirements for fire safety are that structures must be designed and built such that, in the case of fire:

- load-bearing capacity can be assumed to be maintained for a specific period of time
- the generation and spread of fire and smoke is limited
- the spread of fire to neighbouring structures is limited
- occupants can leave the building or be rescued by other means
- the safety of rescue teams is taken into consideration.

Fire resistance means that structural elements, e.g. wall elements, shall withstand a fully developed fire and fulfil requirements of insulation (I), integrity (E) and/or load bearing capacity (R), see figure 7.3. The European system for fire resistance classes is defined in EN 13501-2.

The fire exposure at testing is usually according to the so-called standard time-temperature curve, as defined in the international test standard ISO 834, and referred to in almost all national building codes. In Europe, more detailed versions for different applications have been published in series EN 1363, EN 1364, EN 1365 and EN 1634. This time-temperature curve specifies a fire exposure with ever-increasing temperatures that building elements shall withstand for a specified period of time, e.g. 60 minutes. Timber structures can obtain high fire resistance, e.g. REI 60, REI 90 or even higher.

The fire resistance of timber elements can also be achieved by calculation according to Eurocode 5.

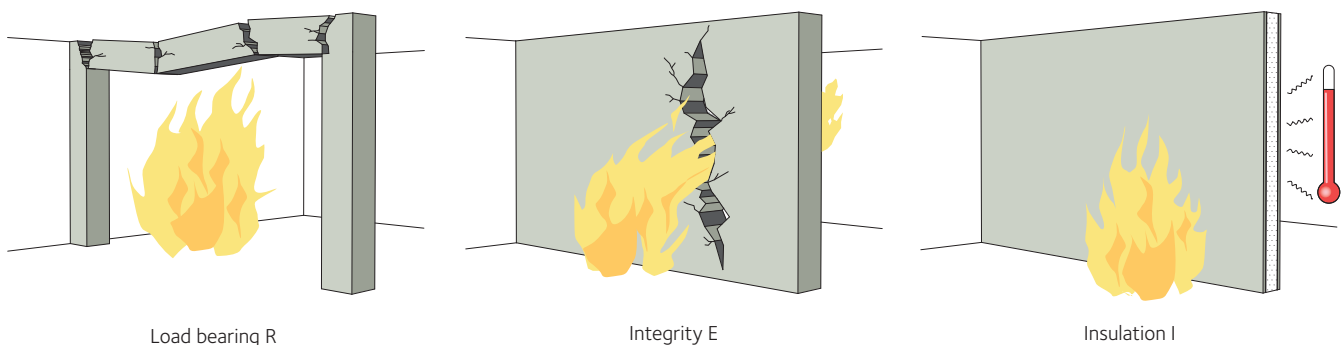

Figure 7.3 Performance criteria for fire resistance

They are used together with a time value, e.g. REI 60 for an element that maintains its load-bearing and separating functions for 60 minutes.



Office building made of CLT, Ålta, Sweden.

7.2 Fire resistance of CLT

For CLT panels that comprise an odd number of layers of set thicknesses, the connections between two layers are assumed to be able to transfer shear forces under the effect of fire. When modelling CLT panels regarding bending, the outer layers and layers parallel with the outer layers are usually considered to be load-bearing. Transverse layers are not considered directly load-bearing, but they help to transfer shear forces between the layers in the longitudinal direction.

A fire safety calculation method for CLT is not included in EN 1995-1-2. However, there are state-of-the-art test-based methods that may be used, see *Fire Safe Use of Wood in Buildings – Global Design Guide*.

There are also other possible design routes to be used, e.g. performance-based design, tests, advanced modelling and combinations thereof.

Fire design of glued timber elements has to consider the type of adhesive used. This is especially true for cross-laminated timber (CLT), which may show falling off of charring layers (“delamination”) at fire exposure. Heat-resistant adhesives (i.e. without delamination) are mainly phenolic and amino-plastic adhesives, but some polyurethane adhesives are also now available. The fire performance of a specific adhesive depends on the chemical composition rather than the group of adhesives it belongs to. Since not all producers of CLT use heat-resistant adhesives, it is important to verify that the material is produced with heat-resistant adhesive if required.

7.2.1 Charring and influence of CLT adhesive properties

If a layer of cross-laminated timber (CLT) is made up of edge-glued boards, or if the gap between two boards is less than 2 mm, one-dimensional charring should be used, as set out in *equation 7.1*:

$$7.1 \quad d_{\text{char},0} = \beta_0 t$$

where:

- β_0 is 0.65 mm/min and is a one-dimensional charring rate in a standard fire.
- t is the fire exposure time.

If the gaps between the boards are greater than or equal to 2 mm, but less than 6 mm, a notional charring rate should be used, as set out in *equation 7.2*:

$$7.2 \quad d_{\text{char},n} = \beta_n t$$

According to *EN 1995-1-2, table 3.1* notional charring rates for wood with a rectangular cross-section that is exposed to fire on three or four sides can be set at:

- β_n is 0.7 mm/min for softwood glulam and LVL.
- β_n is 0.8 mm/min for softwood construction timber (CLT).
- β_n is the equivalent design charring rate, which includes the effect of rounded corners and splits.

There are two possible scenarios for the charring of CLT. With heat-resistant adhesives (i.e. without delamination), the charring takes place at the rate β_0 in the same way as for solid timber. With non-heat-resistant adhesives (i.e. with delamination), the charring rate of the first 25 mm of each lamella is doubled, i.e. $2\beta_0$, see figure 7.4.

7.2.2 Effective cross-section

The design method for load-bearing capacity as presented below follows the general principles in the method for a reduced cross-section, whereby the original cross-section is reduced by an effective charring depth d_{ef} . The effect of temperature increases on the material's properties is considered by part of the cross-section, d_0 , not being included in the effective residual cross-section, h_{ef} . See equations 7.3 and 7.4:

$$d_{ef} = d_{char,0} + d_0 \quad 7.3$$

or:

$$d_{ef} = d_{char,n} + d_0 \quad 7.4$$

Tables 7.1–7.3, page 104, contain several formulae for the non-load-bearing layer d_0 , which are based on test results and thermal simulations. d_0 values can also be given in country specific approval or from accredited laboratories assessment.

For CLT used in floor structures, the simplified method has been adapted to the results of simulations, where the best conformity was achieved between 20 percent and 40 percent of the load-bearing capacity at normal temperature for up to 120 minutes in a standard fire.

The equivalent design for walls was performed for the load condition of 30 percent of load-bearing capacity.

The method should not be used for fire conditions of longer than two hours. The fire protection effect of cladding (panels and insulation on the side exposed to fire) is considered as set out in EN 1995-1-2. If the remainder of a load-bearing layer is less than 3 mm, it should not be included in the calculation of effective residual cross-section, h_{ef} .

d_0 is determined by:

- No. of layers.
- Thickness of CLT panel.
- Type of stress, tension or compression on the side exposed to fire.
- Temperature gradient beneath char layer, i.e. whether the layer is protected or unprotected.

For CLT panels that are exposed to fire on one side, the values for the thickness of the non-load-bearing layers, d_0 , are taken from tables 7.1–7.3, page 104. When exposed to fire, wooden walls bend out from the fire, which means that tensile stresses can only arise on the non-exposed side of the wall, and thus d_0 is only stated for fire exposure on the compressed side. Walls that are exposed to fire on both sides should be designed using test-related base values.

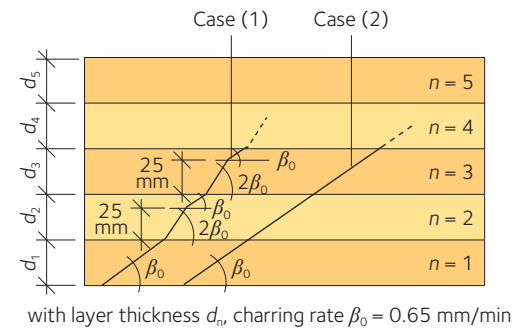

Figure 7.4 Charring with and without delamination of charred layers

7.2 Fire resistance of CLT

Table 7.1 Non-load-bearing layer, d_0 , for $t = 0 - 120$ minutes for CLT panel with 3 layers

Fire on	Floor slab		Wall panel	
	Unprotected surface (mm)	Protected surface ¹⁾ (mm)	Unprotected surface (mm)	Protected surface ¹⁾ (mm)
Panel's side under tension	$d_0 = \frac{h_{CLT}}{30} + 3.7$	$d_0 = 10$	Not relevant	Not relevant
Panel's side under compression	$d_0 = \frac{h_{CLT}}{25} + 4.5$	$d_0 = \min \left\{ \begin{array}{l} 13.5 \\ \frac{h_{CLT}}{12.5} + 7 \end{array} \right.$	$d_0 = \frac{h_{CLT}}{25} + 3.95$	$d_0 = \min \left\{ \begin{array}{l} 13.5 \\ \frac{h_{CLT}}{12.5} + 7 \end{array} \right.$

¹⁾ The values can also be used for $t > t_p$, where t_p is the time when the protection ceases to function, known as the failure time.

Table 7.2 Non-load-bearing layer, d_0 , for $t = 0 - 120$ minutes for CLT panel with 5 layers

Fire on	Floor slab		Wall panel	
	Unprotected surface (mm)	Protected surface ¹⁾ (mm)	Unprotected surface (mm)	Protected surface ¹⁾ (mm)
Panel's side under tension	$d_0 = \frac{h_{CLT}}{100} + 10$	$75 \text{ mm} \leq h_{CLT} \leq 100 \text{ mm}$ $d_0 = 34 - \frac{h_{CLT}}{4}$ $h_{CLT} > 100 \text{ mm}$ $d_0 = \frac{h_{CLT}}{35} + 6$	Not relevant	Not relevant
Panel's side under compression	$d_0 = \frac{h_{CLT}}{20} + 11$	$d_0 = 18$	$d_0 = \frac{h_{CLT}}{15} + 10.5$	$d_0 = 20$

¹⁾ The values can also be used for $t > t_p$, where t_p is the time when the protection ceases to function, known as the failure time.

Table 7.3 Non-load-bearing layer, d_0 , for $t = 0 - 120$ minutes for CLT panel with 7 layers

Fire on	Floor slab		Wall panel	
	Unprotected surface (mm)	Protected surface ¹⁾ (mm)	Unprotected surface (mm)	Protected surface ¹⁾ (mm)
Panel's side under tension	$105 \text{ mm} \leq h_{CLT} \leq 175 \text{ mm}$ $d_0 = \frac{h_{CLT}}{6} + 2.5$ $h_{CLT} > 175 \text{ mm}$ $d_0 = 10$	Same as unprotected surface	Not relevant	Not relevant
Panel's side under compression	$105 \text{ mm} \leq h_{CLT} \leq 175 \text{ mm}$ $d_0 = \frac{h_{CLT}}{6} + 2.5$ $h_{CLT} > 175 \text{ mm}$ $d_0 = 13$	Same as unprotected surface	$105 \text{ mm} \leq h_{CLT} \leq 175 \text{ mm}$ $d_0 = \frac{h_{CLT}}{6} + 4.0$ $h_{CLT} > 175 \text{ mm}$ $d_0 = 16$	Same as unprotected surface

¹⁾ The values can also be used for $t > t_p$, where t_p is the time when the protection ceases to function, known as the failure time.

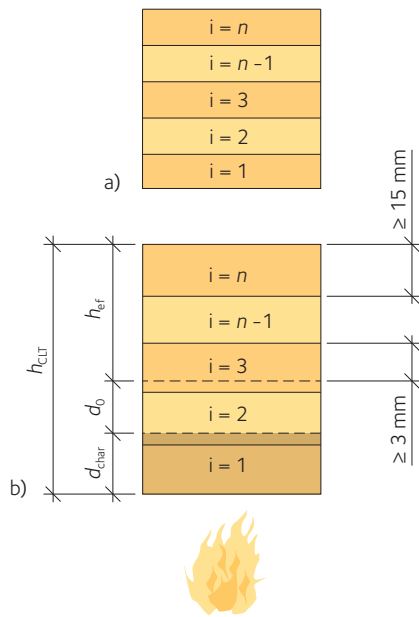

Figure 7.5 CLT cross-section
a) Cross-section at normal temperature.
b) Residual cross-section h_{eff} , char layer d_{char} and non-load-bearing layer d_0 for single-sided fire exposure.

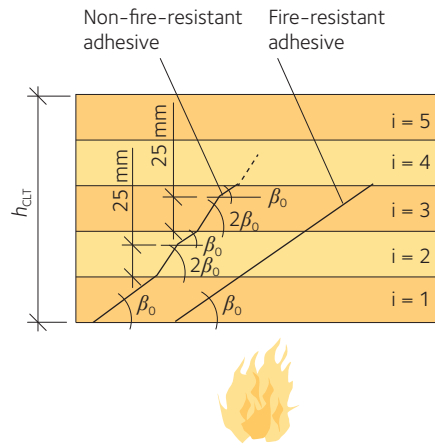

Figure 7.6 Charring of CLT with non-fire-resistant adhesive (with delamination) and fire-resistant adhesive (no delamination)

7.2.3 Design loads in event of fire

The design load for a structural element in the fire load case (according to Eurocode) is the accidental load, and the structure's load-bearing capacity in a fire must be verified for every element by meeting the criterion in equation 7.5:

$$A_{\text{d,f}}(t) \leq R_{\text{d,f}}(t) \quad 7.5$$

where:

- $A_{\text{d,f}}$ is the design value for a load in a fire.
- $R_{\text{d,f}}$ is the load-bearing capacity under the same conditions.
- t is the duration of the fire's effect.

When designing in the fire load case, use the load combination in equation 7.2, page 102, in line with Eurocode 0 and EKS 10:

$$G_k + \psi_{1,1} Q_{k,1} + \sum_{i=1}^n \psi_{2,i} Q_{k,i} \quad 7.6$$

where:

- G_k is the characteristic value for permanent actions.
- $Q_{k,1}$ is the characteristic value for the leading variable action.
- $Q_{k,i}$ is the characteristic value for the other variable actions.
- $\psi_{1,1}$ is the combination factor for the leading variable action.
- $\psi_{2,i}$ is the general combination factor for the other variable actions.

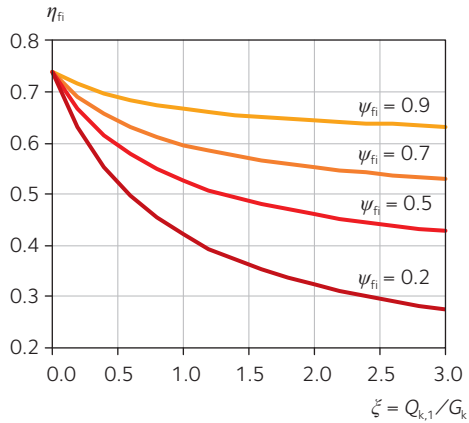

Figure 7.7 Examples of variation in reduction factor η_{fi} with load ratio $\zeta = Q_{k,1}/G_k$.

The combination factors ψ are determined by the different load categories of the structural elements, and usually range between 0 and 0.7. The choice of combination factor must be given consideration if the structural element's maximum load can be expected to occur in a fire situation, such as in a library, archive or warehouse.

A simplified method is to verify the structure's load-bearing capacity in the fire load case based on a reduced load, as set out in EN 1995-1-2, section 2.4.2, where the load effect in a fire $s_{d,fi}$ for an individual structural element is calculated using equation 7.7:

$$E_{d,fi} = \eta_{fi} E_d \quad 7.7$$

where:

E_d is the design load effect when designing for normal temperature.

η_{fi} is the reduction factor for design load in a fire depending on the load ratio $\zeta = Q_{k,1}/G_k$ and the combination factor ψ_{fi} for frequent values for variable actions. The recommended figure for general calculations is $\eta_{fi} = 0.6$. Under an imposed load in category E as set out in Eurocode 1 (areas susceptible to accumulation of goods, including access areas), the recommended value is $\eta_{fi} = 0.7$. The reduction factor η_{fi} can be lower for lightweight floor structures.

For mechanical load-bearing capacity in the fire load case, the design values for strength and stiffness are to be determined using equations 7.8 – 7.11:

$$7.8 \quad f_{d,fi} = k_{mod,fi} \frac{f_{20}}{\gamma_{M,fi}}$$

$$7.9 \quad S_{d,fi} = k_{mod,fi} \frac{S_{20}}{\gamma_{M,fi}}$$

$$7.10 \quad f_{20} = k_{fi} f_k$$

$$7.11 \quad S_{20} = k_{fi} S_{05}$$

where:

$f_{d,fi}$ is the design strength in a fire.

$S_{d,fi}$ is the design stiffness in a fire.

f_{20} is the 20 % fractile strength at normal temperature.

S_{20} is the 20 % fractile stiffness at normal temperature.

$k_{mod,fi}$ is the load duration and moisture modification factor in a fire. Recommended value of 1.0 when using method with reduced cross-section.

$\gamma_{M,fi}$ is the partial factor for wood in a fire. Recommended value 1.0.

k_{fi} Factor for converting 5 % fractile to 20 % fractile. For cross-laminated wood (CLT), $k_{fi} = 1.15$.

7.3 Design and details

Wooden structures have a predictable behaviour pattern in a fire, but structural details must be carefully designed to ensure the complete fire safety of the building. The features that directly affect building with CLT are usually cavities in walls, eaves and conduits for installations.

Construction gaps and joints in fire-resisting elements could present a route for flames and hot gases to spread into neighbouring compartments and therefore must be sealed using fire-stopping materials to prevent the spread of fire.

The fire-stopping of fire resisting elements can be required for many reasons (see figure 7.8):

- Service penetrations
- At the junctions between fire resisting elements
- To prevent exposing the timber structure to high temperatures prior to the failure of the fire protection system.
- To provide continuity of compartmentation into cavity spaces.

Fire-stopping can be tested as part of a full-scale fire test in a wall to BS EN 1365-1, or in floors to BS EN 1365-2, or as small-scale fire tests for different applications to the following standards:

- BS EN 1366-3 – Penetration Seals
- BS EN 1366-4 – Linear Joint Seals.

Any fire-stopping test must be relevant for the construction method being used, and variations between the as-built construction and the tested assembly may invalidate the application of the test results. Alternatively, it may be possible to demonstrate the effect of small gaps and joints using the methods provided in BS EN 1995-1-2 or other guidance documents.

It is best to design-out the need for pipes and services to penetrate fire-resisting elements using dedicated service risers, but they cannot be designed out completely. Different fire stopping strategies exist for different service penetrations depending on the size and type of service. There are a number of different products and systems that can be used as fire barriers. There are sealants for sealing openings and

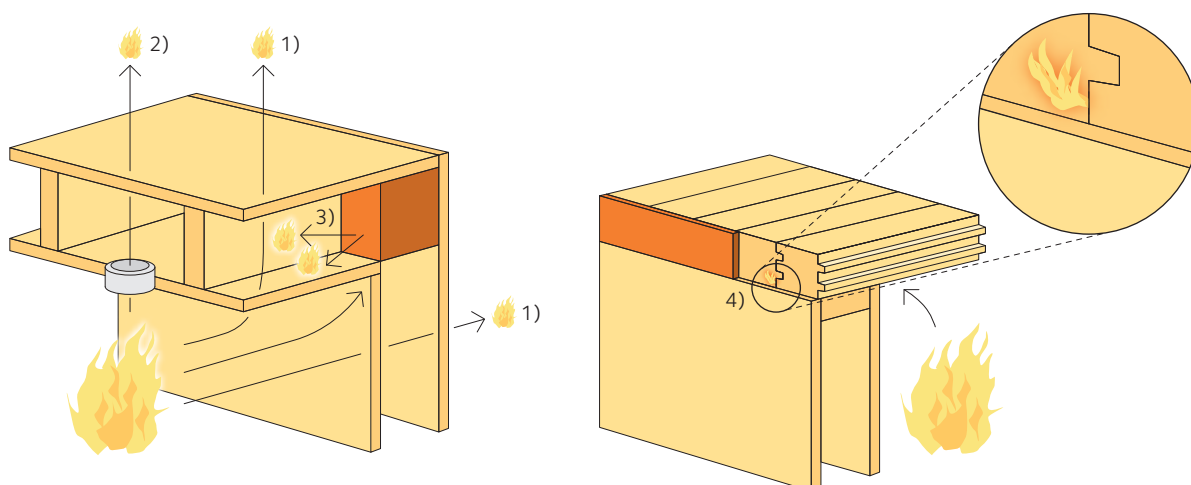

Figure 7.8 Routes for fire to bypass fire-resisting elements

Path 1) The fire resistance of separating walls and flooring can be calculated in accordance with EN 1995-1-2:2006.

Path 2) Penetrations or openings for building services must not degrade the fire resistance of the flooring.

Path 3) Interior wall panels and element joints must be airtight.

Path 4) Continuous element joints in the connection area must be sealed on the front side.



CLT panels ready for supplementary layers.

joints around electrical cables and conduits and through fire compartment separating elements such as walls and floors. Most are certified only for non-combustible structures, but many of these products should also be usable in wooden structures, for example fire retardant sealant, fireproofing tape, fireproof collars/wraps, intumescent sleeves, panels and dampers.

Building elements, such as floors and walls that are required to be fire resistant, must have connections that also achieve the same fire resistance, resist the applied forces and, where required, prevent the passage of heat and flames. Fire tests for connections of assemblies are not included in current standards, but are important for the fire resistance of the whole building. Some details of element connections have been fire-tested in research projects, but until now, no guidelines for element connections have been published.

CLT panels as floor or wall elements are normally connected with a half-lap or a single-surface spline – the most common forms where a fire resistance is required. Each CLT manufacturer will specify a panel-to-panel connector for use with their panels, achieving a fire resistance proven through standardised fire-testing.

Where a building uses CLT for both floors and walls, there will be panel-to-panel connections. Where the floors bear directly on the walls (platform frame construction), the load transfer from the floor to the wall is by direct bearing on the top of the wall. Screws are provided to ensure connectivity between wall and floor panels. The fire resistance of the wall-to-floor connection needs to be determined based on the reduction in cross-section of both the floor and wall panels.

Where CLT panels connect into walls with the walls continuous, the connection is often a timber ledger or a steel angle ledger. The ledger needs to provide a fire resistance to support the floor and to also prevent passage of heat and flame between floors, where the floor acts as a fire separation. A timber ledger must be designed to have sufficient thickness to resist the applied loads with the residual cross-section for the fire resistance period required. A steel angle must be protected to ensure there is no failure of the steel member or the fasteners connecting the angle into the supporting timber wall. There are very few fire tests on ledger fire resistance available.

7.4 Examples

7.4.1 Unprotected floor structure

Design method for a CLT slab used for a floor structure. An unprotected floor slab comprising 7-layer CLT with boards 19 mm thick, exposed to fire from the underside and with less than a 2 mm gap between the boards. Determine the effective slab thickness after 60 minutes of fire exposure.

a) No char ablation (The adhesive used for bonding between laminations is fully effective in fire)

Charring depth after 60 minutes:

$$d_{\text{char},0} = \beta_0 t_{\text{req}} = 0.65 \times 60 = 39 \text{ mm}$$

Non-load-bearing layer for fire on side under tension, according to table 7.3, page 104:

$$d_0 = \frac{h_{\text{CLT}}}{6} + 2.5 = \frac{133}{6} + 2.5 = 25 \text{ mm}$$

Effective depth:

$$h_{\text{ef}} = h_{\text{CLT}} - d_{\text{char},0} - d_0 = 133 - 39 - 25 = 69 \text{ mm}$$

Since the effect of the fire reaches in as far as a transverse, non-load-bearing layer (layer 4), the remaining effective residual cross-section will comprise the three layers 5, 6 and 7, see principle in figure 7.9.

b) Ablation of char layer (char layer not in place)

The failure time for layer 1 is set as equalling the time when layer 2 begins to char:

$$t_{\text{ch}} = t_{f,1} = \frac{h_1}{\beta_0} = \frac{19}{0.65} = 29 \text{ minutes}$$

Charring depth after 60 minutes:

$$d_{\text{char}} = h_1 + (t_{\text{req}} - t_f) \beta_0 k_3 = 19 + (60 - 29) \times 0.65 \times 2 = 59 \text{ mm}$$

k_3 as set out in SS-EN 1995-1-2.

Non-load-bearing layer for fire on side under tension, according to table 7.3, page 104:

$$d_0 = \frac{h_{\text{CLT}}}{6} + 2.5 = \frac{133}{6} + 2.5 = 25 \text{ mm}$$

Residual cross-section:

$$h_{\text{ef}} = h_{\text{CLT}} - d_{\text{char}} - d_0 = 133 - 59 - 25 = 49 \text{ mm}$$

The residual cross-section is 49.3 mm for the unprotected floor slab.

7.4.2 Protected floor structure

Design method for a CLT slab used for a floor structure. The CLT slab is protected by a 12.5 mm gypsum plasterboard panel of type F. The failure time for the plasterboard according to the plasterboard manufacturer is $t_f = 45$ minutes. The floor slab comprises 7-layer CLT made from boards 19 mm thick, and is exposed to fire from the underside. Determine the effective slab thickness after 60 minutes.

No char ablation (The adhesive used for bonding between laminations is fully effective in fire)

$$t_{\text{ch}} = 2,8h_p - 14 = 2.8 \times 12.5 - 14 = 21 \text{ minutes}$$

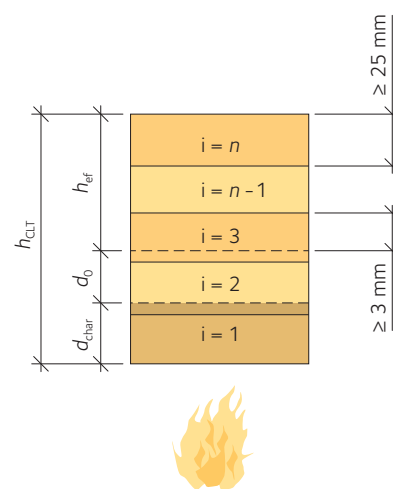

Figure 7.9 Effective cross-section height, h_{ef}



According to EN 1995-1-2, the protection factors for a gypsum plasterboard panel of type F can be expressed as:

$$k_2 = 1 - 0.018h_p = 1 - 0.018 \times 12.5 = 0.775$$

$$k_3 = 2$$

The time limit t_a can be calculated in line with EN 1995-1-2 as:

$$t_a = \frac{25 - (t_f - t_{ch})k_2\beta_0}{k_3\beta_0} + t_f = \frac{25 - (45 - 21) \times 0.775 \times 0.65}{2 \times 0.65} + 45 = 55 \text{ minutes}$$

Charring depth after 60 minutes:

$$d_{char} = 25 + (t_{req} - t_a)\beta_0 = 25 + (60 - 55) \times 0.65 = 28 \text{ mm}$$

Non-load-bearing layer for fire on side under tension, according to table 7.3, page 104:

$$d_0 = \frac{h_{CLT}}{6} + 2.5 = \frac{133}{6} + 2.5 = 25 \text{ mm}$$

Residual cross-section:

$$h_{ef} = h_{CLT} - d_{char} - d_0 = 133 - 28.3 - 24.7 = 80 \text{ mm}$$

By protecting the floor slab on the underside with a 12.5 mm gypsum plasterboard panel of type F, the residual cross-section instead becomes 80 mm.

7.4.3 Unprotected wall panel

Design method for a CLT panel used for a load-bearing wall. A wall panel comprising 5-layer CLT made from boards 19 mm thick, exposed to fire from one side. The calculation assumes that no delamination occurs. Determine the effective panel thickness after 30 minutes:

$$d_{char} = \beta_0 t_{req} = 0.65 \times 30 = 20 \text{ mm}$$

Non-load-bearing layer for fire on side under compression, according to table 7.2, page 104:

$$d_0 = \frac{h_{CLT}}{15} + 10.5 = \frac{95}{15} + 10.5 = 17 \text{ mm}$$

Residual cross-section:

$$h_{ef} = h_{CLT} - d_{char} - d_0 = 95 - 20 - 17 = 58 \text{ mm}$$

The effect of the fire reaches in as far as the first transverse layer (layer 2). This means that around 57 mm of the wall panel remains and that the remaining load-bearing capacity is provided by two vertical layers.

7.4.4 Protected wall panel

Design method for a CLT panel used for a load-bearing wall. A wall panel comprising 5-layer CLT made from boards 19 mm thick, exposed to fire from one side for 60 minutes. The CLT panel's inner side is protected from fire by a 15 mm gypsum plasterboard panel of type F. The failure time for the plasterboard according to the plasterboard manufacturer is $t_f = 45$ minutes.

Residual cross-section:

$$t_{ch} = 2.8h_p - 14 = 2.8 \times 15 - 14 = 28 \text{ minutes}$$

According to SS-EN 1995-1-2, the protection factors for a gypsum plasterboard panel of type F can be expressed as:

$$k_2 = 1 - 0.018h_p = 1 - 0.018 \times 15 = 0.73$$

$$k_3 = 2$$

The time limit t_a can be calculated in line with SS-EN 1995-1-2 as:

$$t_a = \frac{25 - (t_f - t_{ch})k_2\beta_0}{k_3\beta_0} + t_f = \frac{25 - (45 - 28) \times 0.73 \times 0.65}{2 \times 0.65} + 45 = 58 \text{ minutes}$$

Charring depth after 60 minutes:

$$d_{char} = 25 + (t_{req} - t_a)\beta_0 = 25 + (60 - 58) \times 0.65 = 26 \text{ mm}$$

Non-load-bearing layer for fire on side under compression, according to table 7.2, page 104:

$$d_0 = 20 \text{ mm}$$

Residual cross-section:

$$h_{ef} = h_{CLT} - d_{char} - d_0 = 95 - 26 - 20 = 49 \text{ mm}$$

This means that two vertical layers remain, with one layer fully intact and around 11 mm of the other vertical layer remaining after 60 minutes of fire. Both layers are load-bearing.

Table 7.4 Characteristic load-bearing capacity of CLT wall panels exposed to fire on one side

CLT panel and supplementary layers	Load-bearing capacity after 30 min (kN/m)	Load-bearing capacity after 60 min (kN/m)	Load-bearing capacity after 90 min (kN/m)
5 × 19 mm in cold state; 277 kN/m	–	–	–
5 × 19 mm + GtA 13	159	6.5	–
5 × 19 mm + GtF 15	159	82	0.6
5 × 19 mm + GtF 15 + GtA 13	159	159	154
5 × 19 mm + GtF 15 + 15 GtF 15	159	159	159
5 × 19 mm + GtA 13 + mineral wool 45	159	159	6.1

Background: CLT panel 5 × 19 mm, height 2.8 m, centric load, no side loads, timber in all layers has minimum strength class of C24. Load-bearing capacity in cold state 277 kN/m.

Failure time for gypsum plasterboard (Gt): GtA $t_f = 21$ minutes, GtF $t_f = 45$ minutes, GtF + GtA $t_f = 80$ minutes.

CLT and sound

- 8.1 Background 112
 - 8.1.1 Sound insulation ratings 113
 - 8.1.2 Airborne sound insulation 113
 - 8.1.3 Impact sound insulation rating 114
- 8.2 Acoustic strategy 115
 - 8.2.1 Building usage and regulatory or design requirements 115
 - 8.2.2 Pre-Completion Testing (PCT) and Robust Standard Details (RSD) 116
 - 8.2.3 Privacy and background noise 116
 - 8.2.4 Building layout 117
 - 8.2.5 Ceilings 117
 - 8.2.6 Floor coverings 118
 - 8.2.7 Internal sources of noise 118
 - 8.2.8 Structural design 118
- 8.3 Floor constructions 119
 - 8.3.1 Flat floor constructions 119
 - 8.3.2 Cassette constructions 120
 - 8.3.3 Combined CLT and concrete constructions 120
- 8.4 Wall constructions 122
 - 8.4.1 Single panel constructions 122
 - 8.4.2 Double panel constructions 124
- 8.5 Junctions and flanking 125
 - 8.5.1 Floors as horizontal flanking elements 126
 - 8.5.2 Walls or external façades as vertical flanking elements 128
 - 8.5.3 Walls or façades as horizontal flanking elements 130

8.1 Background

As a relatively lightweight and stiff material, CLT transmits sound efficiently and must be used with care in order to achieve good acoustic outcomes in completed buildings.

Generally, it is necessary to consider CLT wall or floor constructions not simply as “separating” elements – for example, a wall separating one room from another – but as a component part of an ensemble of inter-connected elements, because sound transmission will not just occur directly through a separating element (direct transmission) but also via other connected or flanking elements (flanking transmission). For example, a continuous CLT floor construction that runs through from one space to another is a flanking element in relation to the separating wall.

A distinction is made between airborne sound transmission, in which sources first excite the air around them (e.g. someone talking), and impact sound transmission, in which a source directly excites the floor of a building (e.g. footsteps) mechanically. Both of these modes of transmission must be considered. In addition, room acoustics – the way in which a space sounds in relation to the sources within it – is often an important consideration, for example in classrooms where the duration of reflected sound energy (reverberation) must be controlled to provide good speech intelligibility. For room acoustics, the mainly sound reflective surface characteristics of CLT must be considered, and some form of more sound-absorbing finish or covering may be required. A further critical consideration in most buildings is control of noise ingress from external environmental sources, such as transportation noise. In this context, roof constructions, windows, and ventilation openings are the most influential elements.

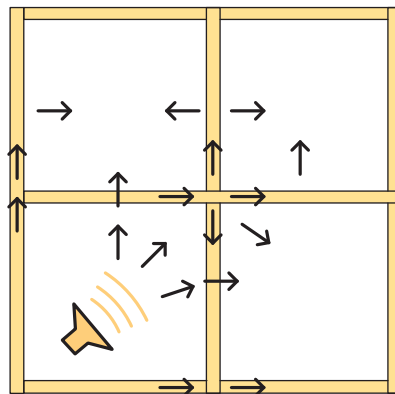

Figure 8.1 Examples of different transmission routes for airborne sound

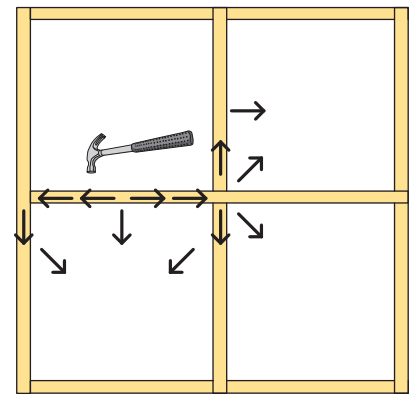

Figure 8.2 Examples of different transmission routes for impact sound

8.1.1 Sound insulation ratings

Regulations and guidance documents employ a quite arcane system of ratings for sound insulation – the degree to which a construction resists either airborne or impact sound transmission – and some background is necessary. Much testing and characterisation is done in the “frequency domain”. In building acoustics, for psychoacoustic reasons as well as convenience, it is conventional to do this in terms of octave-bands or fractional-octave-bands, whereby numerical values of sound insulation (or absorption) of elements are set out as a spectrum of octave-band or 1/3-octave-band values over a frequency range extending from 100 Hz to 4 kHz, although sometimes this range is extended.

In setting acoustic performance figures, it is common, purely for reasons of simplification, to reduce the spectrum of performance for a particular element to a single figure, often described as a single figure “rating”, and often designated by a subscript “w”. For example, R_w is the single figure rating used to describe the airborne sound insulation performance of a building element. It is known as the “weighted sound reduction index” and is expressed as a decibel quantity, e.g. 50 dB R_w .

8.1.2 Airborne sound insulation

For an in-situ separating wall or floor with associated flanking constructions, the most common single figure rating according to the ISO system is the weighted standardized room-to-room sound level difference, $D_{nT,w}$, in dB. The standard method for obtaining this rating is to fit a standard reference curve against the measured, normalised room-to-room level-difference (D_{nT}) spectrum. This can be understood as the weighted room-to-room level difference that would occur if the reverberation time (RT) within the receiving room was 0.5 s in each octave-band. In laboratory tests on separating walls and floors, a weighted sound reduction index R_w is obtained.¹⁾

It is important to understand the difference between the sound level difference D , and the sound reduction index R , which is also often employed for separating elements. Whereas the R rating can be considered a property of the separating element, D is a measure of the “end-result” of airborne sound transmission across the separating element, along with the associated flanking elements, post construction.

As a rough order of magnitude, $D_{nT,w}$ values, assuming reasonably well-performing flanking elements, might be expected to be around 5 dB lower than the R_w rating for the separating element alone, noting that well-performing flanking elements need to be assured by design and attention to junction detailing.

Spectrum adaptation terms

For residential sound insulation in the UK, a modified spectrum curve is used. This curve has relatively greater low frequency content, principally to take account of the effect of low frequency components present in home entertainment systems. Rating according to this curve results in the spectrum-adapted weighted standardized room-to-room sound level difference, $D_{nT,w} + C_{tr}$, values in dB, which is numerically lower than the corresponding $D_{nT,w}$ value. It is worth noting in passing that this is not the approach taken in most other countries, and there is as yet no internationally harmonized rating or regulation.

In the case of both $D_{nT,w}$ and $D_{nT,w} + C_{tr}$ rating values, the lower limit of the frequencies taken into account is 100 Hz. While this is generally adequate for concrete or masonry constructions, CLT will tend to transmit relatively more sound energy below 100 Hz, and it is good practice to take account of transmission in the 63 Hz octave frequency band, meaning that a lower limit of 50 Hz for the frequency range considered is appropriate. This can be done by employing the $C_{tr,50-5000}$ frequency extended spectrum adaptation term. It must be acknowledged that there are difficulties in obtaining reliable test figures at lower frequencies down to 50 Hz, owing principally to lower modal densities in this frequency range in realistically sized test arrangements. Nevertheless, it is important that the potential for relatively efficient transmission, and therefore poorer performance in this frequency range, is considered.

For convenience, this document note will generally refer only to R_w and $R_w + C_{tr}$ values for airborne sound insulation of particular constructions, because these are obtained in laboratory tests and therefore may be provided by suppliers.

8.1.3 Impact sound insulation rating

For impact sound, the general approach is to test a floor with a standard impact-producing source placed on top of the specimen floor (in the “source” room), and then to measure the spectrum of sound level produced in the room below (the “receiver” room). The lower the noise level, the better the performance. Because the noise level in the receiver room is also affected by the effective quantity of acoustic absorption in that room, it is necessary to “normalise” the result to the result that would be obtained for 10 m² of absorption at each frequency in the receiver room. Normalised results are designated by the subscript “n”²⁾.

The standard method for rating impact sound insulation is to fit a standard spectrum curve to the measured (normalised) result spectrum, in a similar fashion to the airborne rating system. For an in-situ separating floor and associated flanking constructions, the single figure rating according to the ISO system is the weighted standardized impact sound pressure level, $L'_{nT,w}$, in dB. This is the average sound pressure level that would be produced by a standard tapping machine if the RT within the receiving room was 0.5 s in each octave-band. In laboratory tests on separating floors, a weighted normalized impact sound pressure level $L_{n,w}$ is obtained.

As a very rough order of magnitude, $L'_{nT,w}$ values – again, making an assumption regarding no gross flanking transmission – might be expected to be up to 5 dB higher than the $L_{n,w}$ rating for the separating floor alone. For convenience, this note will refer only to $L_{n,w}$ values for impact sound insulation, again because these will be obtained in laboratory tests and therefore may appear in suppliers’ literature.

It is important to note that there are significant issues that affect the usefulness of single-figure impact sound insulation ratings obtained in this way, and these are particularly relevant to CLT constructions (in fact to timber constructions generally).

Impact sound level spectrum shape

There is evidence that people are sensitive to impact sound spectra in a way that is not always accounted for by the standard rating method. This tends to mean that, while the rating method results in a defensible rank-ordering of performance of concrete floors, it is much less

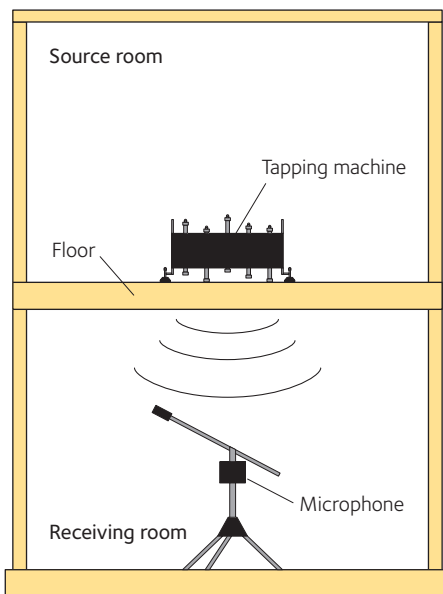

Figure 8.3 Measurement of impact sound transmission

reliable with timber floors. In particular, the low frequency “thudding” often ascribed to timber floors, and revealed as a low frequency spectrum bulge in the measured impact sound level, is not properly represented by the single figure rating. In addition, there are some technical limitations to the ISO tapping machine normally employed in the UK. Real sources of impact sound are generally categorised as either light (footsteps in high-heeled shoes), or heavy (running, jumping, footsteps in bare feet). The ISO tapping machine is ill-suited to simulating the effect of heavy impacts, in particular, in a manner that allows appropriate rank-ordering of floors.

Spectrum adaptation terms

As a means of better representing the effect of noise generated by walking, the ISO system allows for a “spectrum adaptation” term, C_i , (essentially a numerical correction which is added to the $L_{n,w}$ value) to be determined during testing with a standard tapping machine, according to the method described in BS EN ISO 717-2:2013. The frequency range over which C_i is calculated is normally from 100 Hz to 2500 Hz, but it can be extended down to 50 Hz (denoted $C_{i,50-2500}$) or even lower. As with airborne rating, it is highly advisable that this extended frequency range is considered, and there is evidence that performance down to 20 Hz is subjectively important. Testing at such low frequencies, however, is subject to very significant uncertainty.

The C_i term has been normalized so that it is normally zero for heavy floors with a soft or isolated walking surface. However, for light-weight floors the C_i term will generally be positive, thereby increasing the overall ($L_{n,w} + C_i$) impact sound rating level. One approach would be to design to an overall ($L_{n,w} + C_i$) rating no higher than the $L_{n,w}$ requirement. Because of its wide use and applicability, in this document ranges of $L_{n,w}$ figures are generally stated for construction types.

8.2 Acoustic strategy

In the design of any building for which acoustic requirements are important, it is normal and necessary practice for a specialist acoustic consultant to be employed. Because of the high dependency of acoustic behaviour on the precise construction and detailing employed in any given situation, the guidance in this chapter is necessarily intended as conceptual guidance and a starting point for design, in the expectation of specialist input into a detailed design process and prototype testing to prove performance.

It is critical that an overall acoustic strategy is developed at the outset covering a number of key points:

8.2.1 Building usage and regulatory or design requirements

Required acoustic performance will naturally depend on usage, client perspectives, and the regulatory, guidance and sustainability context. In the UK there are legal requirements within Approved Document E of the UK Building Regulations that effectively set out minimum requirements for residential and school buildings. Other guidance, such as British Council for Offices (BCO) guidance and HTM 08-01, is generally applied to commercial buildings and healthcare facilities respectively. Sustainability schemes, such as BREEAM or the WELL Standard, set out the basis for credits to be awarded depending on

Table 8.1 Typical design standards and compatible CLT construction typologies for different building types

		Residential internal walls and floors	Commercial	Education	Residential party walls and floors	
					Minimum	Enhanced
Airborne sound insulation, dB	R_w	≥ 40	≥ 45	≥ 50	≥ 60	≥ 65
	$R_w + C_{tr}$				≥ 50	≥ 55
Impact sound insulation, dB	$L_{n,w}$	≤ 65	≤ 65	≤ 60	≤ 55	≤ 50
	$L_{n,w+C_i,50-2500}$				≤ 55*	≤ 50*
Examples of compatible constructions (see Tables 8.2–8.5)	Floors	1d, 2a	1d, 2b, 2c	1c, 1e, 2c, 2d	1e, 2d, 2e	2e
	Walls	3c, 4a	3c, 3d, 4b	3d, 4b, 4c, 4d	3d, 4c, 4d	3d, 4d

* In residential buildings, the low frequency impact sound performance is especially critical and not properly accounted for in the typically required rating.



Example of vibration-damping intermediate layer.

acoustic performance levels. It is normally necessary for detailed discussion on standards to be adopted to take place at an early stage with all relevant stakeholders, in the context of the implications for design in terms of quality, cost, complexity, sustainability and construction dimensions.

Nevertheless, it is useful in this document to summarise commonly adopted performance standards, notwithstanding individual project requirements and the limitations of the rating systems noted above. The table above indicates typical required sound insulation performance levels for building types. These are approximate values based primarily on experience within the UK, and naturally will be subject to significant variation according to individual project requirements and international code requirements, noting that different rating indices are used in various countries and contexts. The ratings and values shown below are order-of-magnitude indications based on prototype or product tests.

8.2.2 Pre-Completion Testing (PCT) and Robust Standard Details (RSD)

When Approved Document E, which applies in England, was revised in 2000, it set out for the first time explicit performance requirements for airborne and impact sound insulation, and a system of in-situ Pre-Completion Testing (PCT) as a way of verifying that those requirements are met. Most developments therefore will need to undergo testing under the auspices of Building Control, but, as an alternative, Robust Standard Details (RSD) were established. If these details (now approved by Robust Details Ltd) for separating wall and floor constructions are used in their entirety, PCT is not required. However, the robust details are very specific, and in practice many developments take the PCT route to compliance. Robust Details Ltd provide masonry, timber and drywall constructions, and concrete, concrete composite and timber floor constructions. No CLT constructions are yet included, but the RSD system provides a path for future inclusion.

8.2.3 Privacy and background noise

When setting standards for sound insulation, it is important to consider likely background noise levels, especially where mechanical or other continuous noise sources are present. This is because limited levels of background noise provide useful masking of otherwise intrusive sounds. In mechanically serviced apartments, for example,

noise from whole-house ventilation or fan coil systems enhances the privacy provided by the separating constructions in that way. However, care needs to be taken not to assume masking from systems that will not run permanently. It may be possible artificially to sustain moderate continuous background noise masking as part of the design, for example through incorporation of external water features. This can be a useful feature, particularly in situations where opened windows increase the risk of transfer between residential units.

8.2.4 Building layout

Good layout, avoiding adjacencies between noisy and sensitive spaces as far as possible, is paramount. This avoids inflating the required acoustic performance of separating and flanking constructions. When done well, good layout can effectively establish the feasibility of a particular construction form, and vice-versa.

Key layout considerations in residential buildings are as follows:

- Lobbied entrances in apartments greatly reduce risk of disturbance from corridors and landings.
- Vertical stacking of bathrooms simplifies acoustic containment of waste and drainage pipes, avoiding potentially noisy lateral transpositions.
- Bedrooms should be located away from mechanical equipment, kitchens and noisier open-plan living spaces.
- Lifts can cause noticeable structure-borne noise. They should be located away from sensitive living spaces and stores, or other non-sensitive buffers should be employed where possible. Independent linings should be provided where shafts must be located adjacent to living spaces.

8.2.5 Ceilings

The question of whether or not ceilings can be used as part of the acoustic strategy, and whether CLT soffits must be visible, has many implications.

- Use of continuous ceilings offers significant advantages in terms of achievable vertical separation and also horizontal separation where the soffit becomes a flanking element, both in terms of airborne and impact sound insulation. It is often more meaningful to consider the performance of floor and ceiling constructions in combination, than to consider them separately.
- Ceilings also provide a useful visual and acoustic cover for partition head details or high-level services penetration details. Without ceilings, visually acceptable and acoustically effective detailing is significantly harder to achieve.
- Where ceilings are used in this way, any openings or penetrations in the ceiling can undermine performance significantly. Therefore, a strongly related design issue is the building services design (for which ceiling mounted grilles or return air openings may be needed) and light fittings or ceiling mounted loudspeakers (for which individual acoustic enclosures behind the fixtures may be required). In this case only light fittings that are thermally and fire compatible with encapsulation in this way must be selected. The services design strategy generally must be considered alongside the acoustic strategy at an early stage.

8.2.6 Floor coverings

Impact sound transmission control is a significant consideration with CLT (see below) and a floor build-up that reduces impact sound at source will be required. Resilient layers are required to ensure that hard walking surfaces are isolated, and that vertical – and often lateral – transmission of footstep noise can be controlled. The following points should be noted:

- Better low frequency impact sound performance is obtained by more massive constructions (generally including floating concrete toppings) regardless of other isolation measures, and this is a major consideration in residential buildings especially.
- Care needs to be taken to ensure that a soft joint is provided at the floor perimeter and the skirting boards are clear of the walking surface to avoid acoustic bridging.
- The performance of proprietary impact sound-reducing materials such as rubber matting may well have been laboratory tested using a standard concrete arrangement. However, this means that these performance levels will not be valid for other structural floor types, including CLT floors.
- As well as vertical transfer of impact sound, the conditions for lateral transfer must be considered – for example, transfer from corridors or stairs into adjacent apartments in residential buildings, where resilient connection details can be required.
- In residential buildings, kitchen structural floor units, worksurfaces, and other similar sources of impact sound should be installed above floating floors or otherwise isolated, and not rigidly fixed to the structural floor or partitions.

8.2.7 Internal sources of noise

All mechanical or electrical system components must be selected with great care to ensure not only that internal noise criteria are met, but also to avoid any tonal or other attention-catching features. Equipment mountings, whether for floor-mounting or suspension, will generally need to be resilient to control structure-borne sound transfer. Checks should be made in relation to interaction between operating conditions of equipment (e.g. rotational speeds) and natural frequencies of mountings and floor response. This is especially critical with CLT structures, for which a more conservative approach will be necessary as compared with concrete, and equipment must be located sensibly, away from sensitive areas, in robust enclosures.

8.2.8 Structural design

As with the building services design, the acoustic strategy and structural strategy must be developed together at an early stage for a number of reasons:

- To improve flanking performance across junctions, isolating connections may be required, and if this is not structurally possible, additional linings may be necessary.
- Increased acoustic performance will generally increase floor mass, and so acoustic requirements will have implications for spans, loads and floor inertia.

- Spans in themselves affect sound insulation, and should be taken into account in assessing acoustic performance.
- Aspects of design that affect floor stiffness, such as joist and cavity depths, will have acoustic implications and would therefore need to be assessed.

8.3 Floor constructions

Floor types considered here are broadly aligned with those considered in *Chapter 5, page 69*, that is:

- Flat floor construction (CLT panels with no concrete or additional support).
- Cassette (CLT slab reinforced by glulam joists and webs).
- Combined CLT and concrete floor (CLT slab on the underside with cast concrete above). In acoustic constructions the concrete is normally de-bonded from the CLT via an intervening resilient layer to reduce impact sound transmission. Therefore, the constructions considered here are not composite in a structural sense.

A range of expected acoustic performance levels is set out for each type, showing the effect of variations in thickness and mass, where appropriate in combination with the effect of ceilings as part of an overall build-up. Span dimensions will have an effect acoustically, especially at lower frequencies, as will low frequency interaction with receiving room modes. Where low frequency performance is critical, the potential interaction of floor response and room dimensions should be assessed.

8.3.1 Flat floor constructions

The acoustic performance of bare CLT panels is strongly related to mass and therefore thickness, although there are other factors. Airborne performance is moderate for bare panels, and without any covering or ceiling, impact sound insulation is extremely poor. Bare floor panels would only be suitable in instances where only nominal separation is required, and some combination of isolated walking surface and additional ceiling construction is normally required.

Lightweight floating floors will significantly improve impact sound performance, but will provide only a moderate improvement to airborne performance. Ceilings are essential for significant enhancement of airborne performance, and greater ceiling mass (for example double versus single boarding) and resilient suspension, provide the greatest improvement. A lightweight acoustic damping material (such as mineral fibre) should always be included in the ceiling cavity.

Flat floor constructions do not generally provide high levels of low frequency impact sound isolation, even if overall rating performance requirements are met, and this is a significant consideration for residential buildings.

Continuity of flat floor constructions beneath separating partitions is possible for where there are moderate horizontal separation requirements. For higher levels of performance, discontinuous floor sections at partition lines will be necessary. However, above separating partitions, horizontal flanking will be much improved where ceilings have been employed.



A test house designed for sound measurement, comprising 3 – 4 units.



Example of steel bearing that reduces flanking transmission.

Table 8.2 Example CLT flat floor constructions and indicative acoustic performances

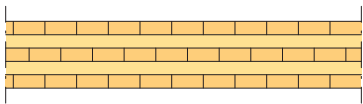
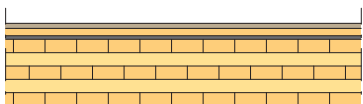
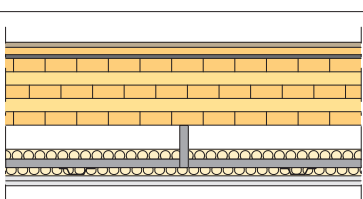
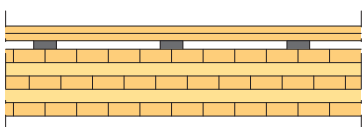
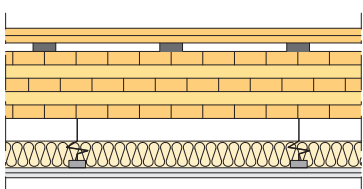
Ref	Construction	Diagram	Depth (mm)	Acoustic performance (dB)		
				R_w	$R_w + C_{tr}$	$L_{n,w}$
1a	Bare CLT slab		135 – 175	36 – 40	33 – 36	85 – 90
1b	As 1a; with hard floor finish and continuous resilient layer (e.g. 10 mm engineered timber on 15 mm plywood or fibre board on 5 – 10 mm resilient mat)		160 – 215	40 – 45	35 – 40	75 – 80
1c	As 1b; with 1 – 2 layers of standard or fire-rated plasterboard suspended on proprietary metal frame ceiling system to give ≥ 100 mm cavity containing ≥ 50 mm mineral wool (16 – 20 kg/m³)		270 – 330	52 – 60	45 – 50	65 – 75
1d	CLT slab with hard floor finish and lightweight pad floating floor system (e.g. 10 mm engineered timber on 40 mm particle board on 25 – 50 mm isolating pads)		180 – 265	42 – 50	37 – 42	60 – 70
1e	As 1d; with 1 – 2 layers of standard or fire-rated plasterboard suspended on proprietary resilient hanger system to give ≥ 100 mm cavity containing ≥ 50 mm mineral wool (16 – 20 kg/m³)		290 – 395	57 – 65	50 – 55	50 – 60

8.3.2 Cassette constructions

Acoustically, cassette constructions are considered as a floor and ceiling combination. An isolated walking surface is required to control impact sound, although control of low frequency impact sound will be limited by the low mass, and this will be a significant limitation for residential buildings especially. Isolation between the cassette and supporting elements (including façade elements) is normally required to control flanking transmission; this can be further improved by independent wall linings. Ceilings are essential, and greater ceiling mass (for example double versus single boarding), cavity depth and independent ceiling supports provide the best performance. A lightweight acoustic damping material (such as mineral fibre) should always be included in the ceiling cavity.

Continuity of cassette constructions beneath separating partitions would cause significant flanking transmission and would not be compatible with many conditions where horizontal acoustic separation is required. However, above separating partitions, horizontal flanking will be much improved where ceilings have been employed.

8.3.3 Combined CLT and concrete constructions

The acoustic performance of bare CLT panels is significantly improved by the presence of a massive topping, although the topping should be de-bonded and isolated from the CLT by an impact sound-reducing

Table 8.3 Example CLT composite floor constructions and indicative acoustic performances

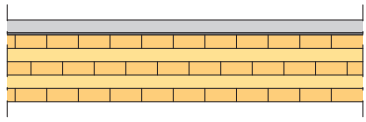
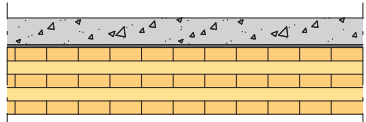
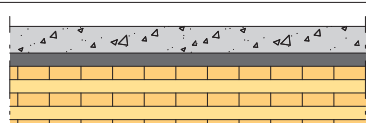
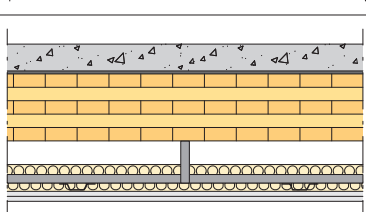
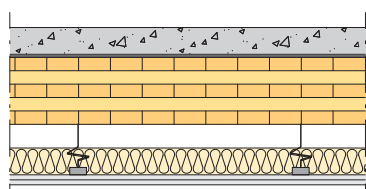
Ref	Construction	Diagram	Depth (mm)	Acoustic performance (dB)		
				R_w	$R_w + C_{tr}$	$L_{n,w}$
2a	135 – 175 mm CLT slab, with dry screed on continuous resilient layer (e.g. 25 – 50 mm high density proprietary screed board on 5-10 mm resilient mat)		165 – 235	40 – 50	35 – 40	65 – 75
2b	135 – 175 mm CLT slab, with 50 – 80 mm screed (1500 kg/m ³) on continuous resilient layer (e.g. 5 – 10 mm resilient mat)		190 – 265	45 – 50	38 – 43	60 – 70
2c	135 – 175 mm CLT slab, with 50-80 mm screed (1500 kg/m ³) on low stiffness resilient layer (e.g. 20 – 30 mm proprietary under-screed mat)		210 – 305	45 – 50	40 – 45	55 – 65
2d	As 2b; with 1 – 2 layers of standard or fire-rated plasterboard suspended on proprietary metal frame ceiling system to give ≥ 100 mm cavity containing ≥ 50 mm mineral wool (16 – 20 kg/m ³)		300 – 395	55 – 65	50 – 55	50 – 60
2e	As 2b; with 1 – 2 layers of standard or fire-rated plasterboard suspended on proprietary resilient hanger system to give ≥ 100 mm cavity containing ≥ 50 mm mineral wool (16 – 20 kg/m ³)		300 – 395	60 – 70	55 – 60	45 – 55

resilient material. Overall performance is strongly related to mass and therefore thickness of both topping and CLT panel, although again there are other factors. This form of CLT construction would be expected to provide the best low frequency performance. Reasonable levels of performance can be achieved without ceilings, but ceilings are generally necessary for enhanced performance – particularly in residential buildings. As before, greater ceiling mass (for example double versus single boarding) and resilient suspension provide the greatest improvement. A lightweight acoustic damping material (such as mineral fibre) should always be included in the ceiling cavity. Measures to control vertical flanking at junctions with façades, such as isolation strips at wall to floor junctions and/or independent linings, will be necessary to maintain performance.

Continuity of combined CLT and concrete floors beneath separating partitions is possible where there are moderate horizontal separation requirements, although the topping should be stopped either side. For higher levels of performance, discontinuous floor sections at partition lines will still be necessary. However, above separating partitions, horizontal flanking will be much improved where ceilings have been employed.

8.4 Wall constructions

Two main wall construction typologies are considered below: single and double CLT panel arrangements. As with the floor constructions, a series of typical wall constructions are presented within each typology along with a range of indicative acoustic performance figures. These ranges serve to illustrate the likely effect of variations in design parameters such as panel thickness, linings and void depth.

As always, the effect of any flanking constructions must also be considered alongside the performance of the separating construction itself. Because of the importance of flanking transmission, additional notes are provided on appropriate junction detailing in a subsequent section below. *Chapter 6, page 86*, provides structural guidance for load-bearing walls, although naturally some internal walls will not necessarily be load-bearing. From an acoustic perspective, the structural role is significant where it dictates connection requirements, or where discontinuities for flanking control are more difficult to achieve.

8.4.1 Single panel constructions

The airborne sound insulation performance of bare CLT panels within frequencies of interest is strongly related to their mass and therefore thickness, although there are other factors. Performance is limited for bare panels of realistic thicknesses, so that the use of bare panels would only be suitable in instances where no significant acoustic separation is required. A particular point of interest relates to the requirement in the UK for internal partitions within dwellings to have a minimum weighted sound reduction of R_{w40} . For this minimum requirement, and for better standards within dwellings, a bare panel alone is not likely to be suitable.

Direct-fixed dry linings to one or both sides of the CLT panel can provide small improvements in acoustic performance. Depending on the thickness of the CLT panel, along with the number and density of linings, this arrangement may prove suitable for some uses requiring lower levels of acoustic separation. For a given overall depth, a thinner CLT panel with linings applied is likely to provide slightly better acoustic separation than a thicker bare CLT panel.

The introduction of a lining on a cavity to one or both sides of the CLT panel can deliver a notable uplift in acoustic performance, depending on the specific arrangement. The following are critical considerations for lined panels:

- The mass of the lining: generally higher performance as mass increases.
- The cavity dimensions between lining and panel: generally higher performance as cavity thickness increases.
- The nature of the fixings between panel and lining: independently supported linings are most effective, while resiliently connected linings are better than rigidly connected.
- The installation of an acoustic damping material, such as mineral fibre, in the cavity.

Lining both sides would be expected to provide the best performance, although in such a case an asymmetrical arrangement should ideally be implemented to avoid coincidence of resonant transmission mechanisms. Suitably detailed double-lined panel constructions will usually provide comparable (or better) acoustic separation than a double CLT panel of equivalent overall depth, depending on configuration.

Therefore, these arrangements can be used to form party wall constructions in residential developments where floor area is at a premium – though much care must be taken to minimise flanking paths (e.g. ensuring discontinuities in floor/ceiling slabs).

It should also be noted that a lining with a minimal but finite air cavity can reduce rather than increase performance; this should therefore be avoided by effectively continuously bonding lining boards directly to the CLT panel with zero air-gap, where a separated lining is not proposed.

Table 8.4 Example CLT single panel wall constructions and indicative acoustic performances

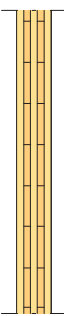
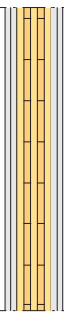
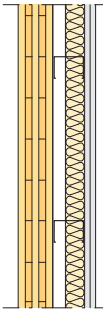
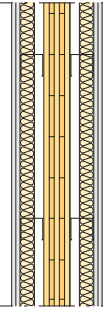
Ref	Construction	Diagram	Depth (mm)	Acoustic performance (dB)	
				R_w	$R_w + C_{tr}$
3a	Bare CLT		78 – 95	30 – 33	27 – 30
3b	As 3a; lined with 1 – 2 layers of standard or fire-rated plasterboard direct-fixed to either side of CLT panel (zero cavity)		103 – 155	35 – 40	33 – 36
3c	As 3a; with lining to one side consisting of 1 – 2 layers of standard or fire-rated plasterboard on 70 mm cavity containing ≥ 50 mm mineral wool ($16 - 20 \text{ kg/m}^3$)		161 – 195	40 – 50	36 – 41
3d	As 3a; with lining to both sides consisting of 2 layers of standard or fire-rated plasterboard on 70 mm cavity containing ≥ 50 mm mineral wool ($16 - 20 \text{ kg/m}^3$)		268 – 295	55 – 65	50 – 55

8.4.2 Double panel constructions

Double panel constructions in principle provide an acoustic advantage over single panel constructions, principally owing to the de-coupling of the two elements and greater overall mass.

Nevertheless, the characteristics of CLT panels mean that, if the construction is not designed carefully, a double CLT panel arrangement may perform at a significantly lower level (particularly at low frequencies) than a twin-frame drywall construction of equivalent overall depth.

Table 8.5 Example CLT double panel wall constructions and indicative acoustic performances

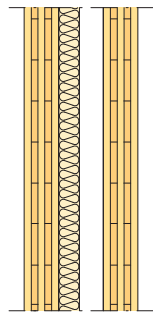
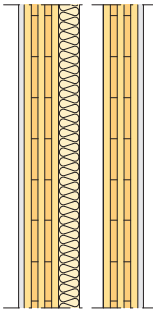
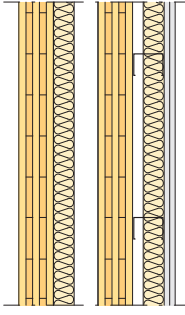
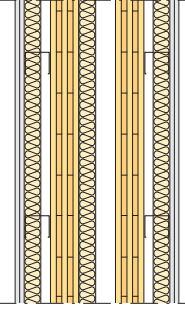
Ref	Construction	Diagram	Depth (mm)	Acoustic performance (dB)	
				R_w	$R_w + C_{tr}$
4a	Two panels of 78 – 94 mm CLT, separated by 50 – 100 mm cavity containing ≥ 50 mm mineral wool (16 – 20 kg/m ³)		206 – 288	42 – 47	37 – 42
4b	As 4a; lined on outside of each panel with 1 – 2 layers of standard or fire-rated plasterboard (no cavity)		231 – 348	50 – 57	43 – 50
4c	As 4a; with lining to outside of one panel consisting of 1 – 2 layers of standard or fire-rated plasterboard on 70 mm cavity containing ≥ 50 mm mineral wool (16 – 20 kg/m ³)		289 – 388	55 – 60	50 – 55
4d	As 4a; with lining to outsides of both panels consisting of 1 – 2 layers of standard or fire-rated plasterboard on 70 mm cavity containing ≥ 50 mm mineral wool (16 – 20 kg/m ³)		372 – 488	55 – 65	50 – 60

Unequal panel thicknesses should ideally be used to improve performance. Further uplifts can be achieved by focusing on maximising the cavity depth rather than the overall mass of the construction, and by introducing acoustic damping materials, e.g. mineral fibre, into the cavity between panels.

As with single panel arrangements, additional surface linings, for example fireboarding, direct-fixed to one or both sides, will normally provide a noticeable benefit to acoustic performance.

Fixed or independent linings forming an additional cavity to one or both sides can provide very good levels of acoustic performance; cavity depths and masses of individual leaves must be varied as much as practicable to avoid the alignment of multiple resonances which can severely affect lower frequency performance.

8.5 Junctions and flanking

Attention to flanking transmission in CLT buildings is especially important because acoustic energy flows readily in lightweight elements and via the extended structural wall and floor connections employed. In CLT constructions, transmission via flanking paths can easily exceed the magnitude of the transmission via the direct path through the separating element, meaning that without control of flanking, the performance of separating elements would be pointless.

Flanking is equally important from an airborne and impact sound transmission point of view, and naturally some measures employed to control one mode of transmission can also be effective in controlling the other, but these perspectives do not always align and it is critical that flanking solutions are considered with both phenomena in mind.

The net effect of transmission via the separating element (direct transmission) together with transmission via all flanking paths must always be considered in their totality in assessing overall transmission between, or separation of, one space and another.

There are two principal means of controlling flanking transmission. The first is through the use of discontinuities and/or resilient inserts, such as between-panel strips or isolating pads, although some rigid bearings are also sometimes employed. Here, the intention is to reduce the coupling between the separating element and flanking elements or to impede energy flow along a flanking path. It is important to note that resilient elements by their nature and by intention introduce resonant behaviour to attenuate sound at frequencies above the resonance they introduce. But at resonance they amplify, and more than one resonant mode (for example vertical and shear) will be introduced. This can, for example, mean that some low frequency components are amplified rather than attenuated. In general, resilient elements can improve flanking performance significantly at mid and high frequencies, but their effectiveness is much reduced at low frequencies. There are also important structural considerations. Resilient elements will deflect according to loads, and so will introduce movement according to fluctuations in load conditions. Equally, they must be able to withstand all compressive, tensile and shear loads. Limits on allowable movement will constrain the type and acoustic performance of the material it is possible to use. Furthermore, fixings through resilient elements will reduce their effectiveness significantly, so the need for fixings should be minimised and non-rigid fixings used wherever possible.

Great care must be taken to understand limitations on performance and to study tested scenarios when assessing the suitability of particular isolation elements or fixings.

Flanking transmission can also be reduced by installing linings in front of flanking elements, either on the source side of the separating element, or on the receiver side, or both. Source-side linings will only be of benefit to reducing airborne flanking, while receiver-side linings will benefit both airborne and impact performance. The effectiveness of linings is improved by increasing mass (number and density of boards used), increasing cavity dimension, removal of mechanical coupling between lining and structure (preferably by independent vertically spanning supports, or resilient restraints) and damping within the cavity. Generally, linings are much more effective at higher frequencies than lower.

Of the two methods, effective reduction of flanking by reducing acoustic coupling at junctions, rather than by linings, is likely to provide a greater magnitude of reduction.

8.5.1 Floors as horizontal flanking elements

Horizontal flanking via floors both below and above separating partitions must be considered. Although horizontal impact sound flanking requirements are rarely stipulated in guidance documents, it is important to consider this aspect as well as airborne flanking, and soft or floating floor coverings may be required for this reason alone.

Flanking below separating partitions will be controlled principally by structural element mass and floating floor construction.

Flanking above separating floors will normally be relatively well controlled by sound-insulating ceilings that stop but are sealed to either side of the partition.

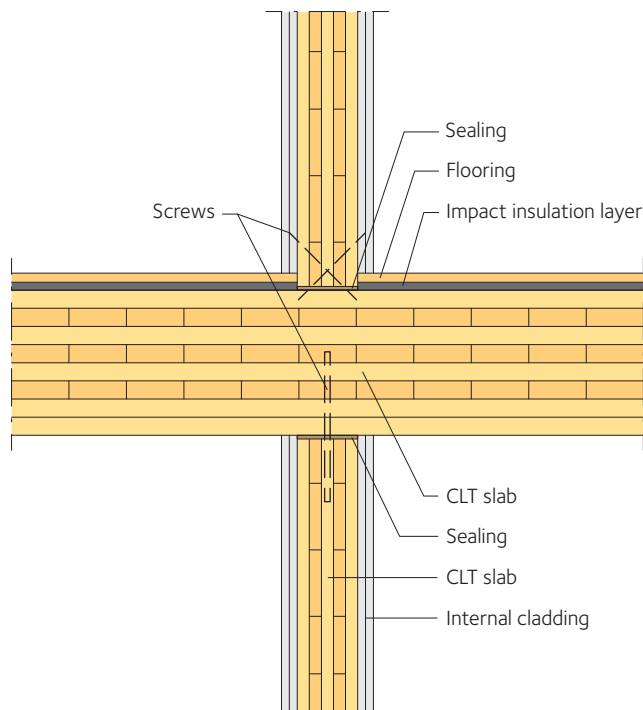

Figure 8.4 Example of (horizontal flanking) junction detail in vertical section across CLT floor slab for low sound insulation

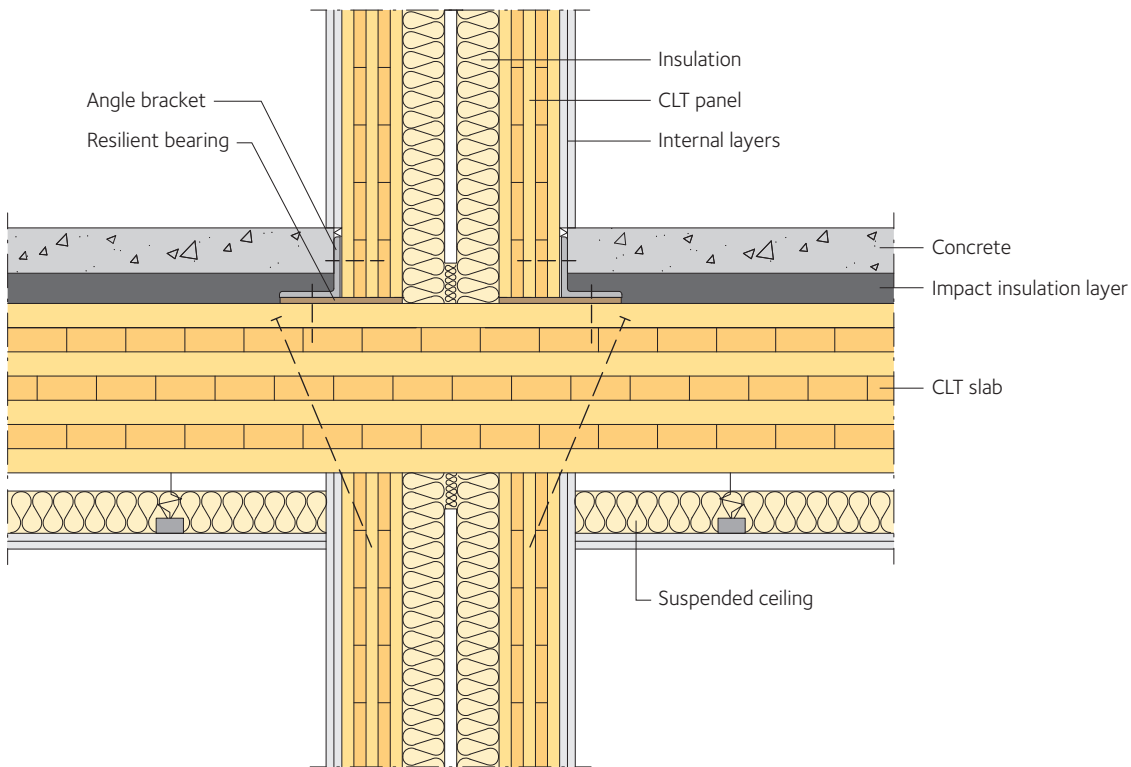

Figure 8.5 Example of (horizontal flanking) junction detail in vertical section across CLT floor slab for medium sound insulation

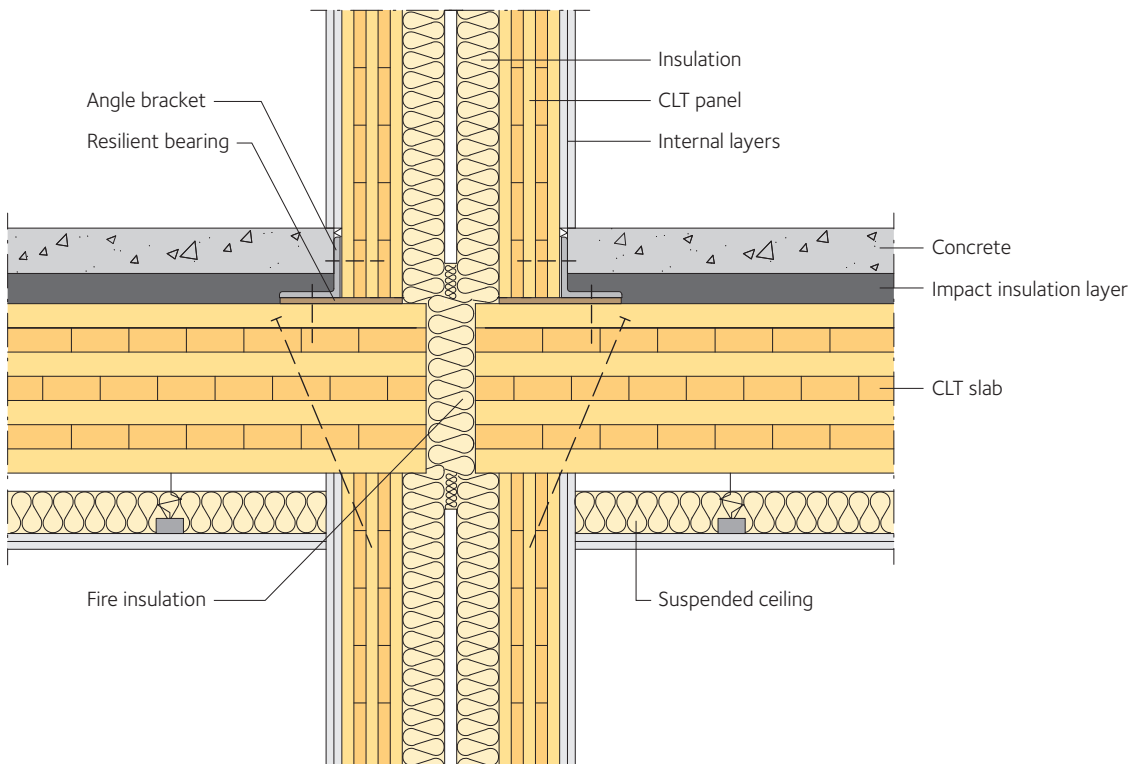

Figure 8.6 Example of (horizontal flanking) junction detail in vertical section across CLT floor slab for high sound insulation

8.5.2 Walls or external façades as vertical flanking elements



Trafalgar Place apartments, London, England.

Airborne flanking around separating floors via walls will be controlled principally by flanking wall element mass, connections into the floor structure from above and below, and the presence or absence of wall linings.

Impact sound flanking will be controlled by the supporting connection between floor and wall, the wall panel mass and the presence or absence of wall linings in the receiving room below. In constructions such as cassette floors, where control of direct impact sound transmission is highly dependent on the ceiling construction, the relative magnitude of coupling between the structural floor and the flanking element will be very significant, and the introduction of resilient junction elements and especially wall linings is important.

By contrast, constructions where control of direct impact sound transmission is predominantly achieved by the floating floor that de-couples the walking surface from the floor structure, the acoustic excitation of the structural elements of the floor connected to the walls is lower and the risk of flanking reduced. This is a better starting point than a pure reliance on de-coupling at junctions and/or wall linings, but these measures can also be used to achieve higher performance.

Impact sound flanking can also occur where sources of impact sound, such as switches, doors, or work surfaces, are rigidly connected to the walls. This flanking is not naturally covered by normal impact testing methods or ratings addressing footsteps, but should be considered. It is closely related to wall panel mass and wall to floor connection details.

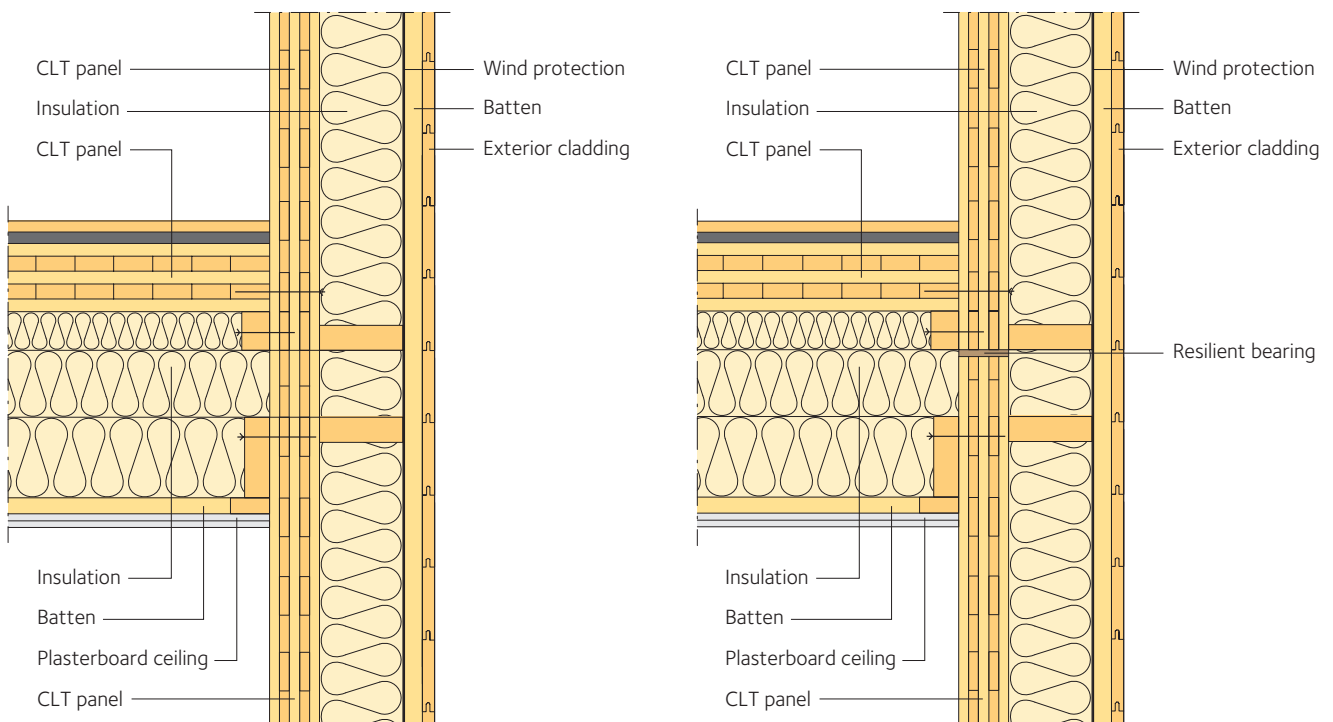

Figure 8.7 Example of (vertical flanking) junction details in vertical section across suspended CLT slab arrangement (left = lower sound insulation; right = higher sound insulation)

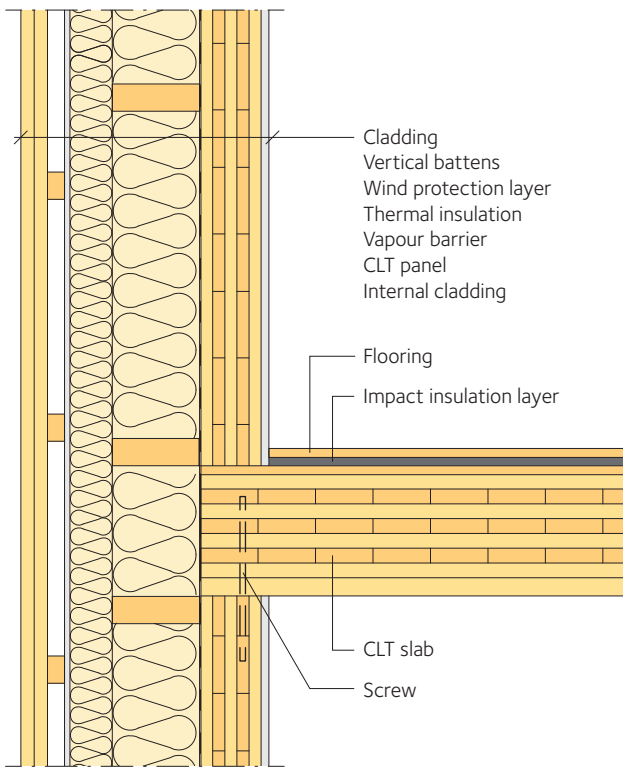

Figure 8.8 Example of (vertical flanking) junction detail in vertical section across supported CLT slab (lower sound insulation)

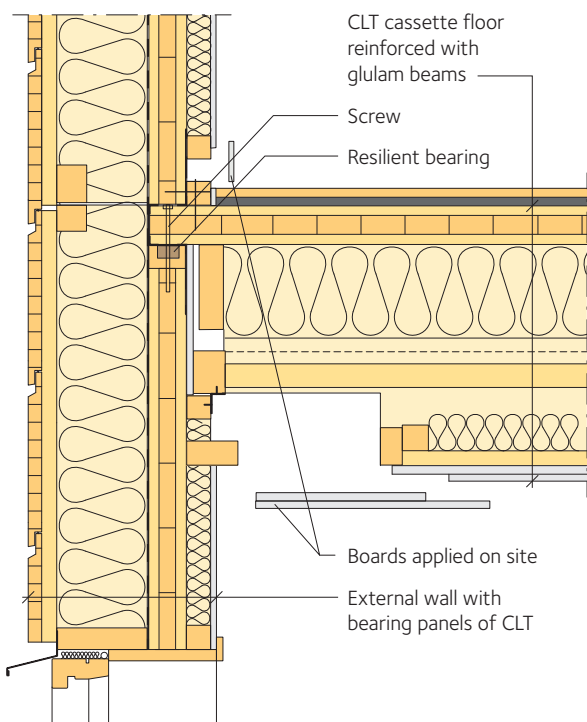

Figure 8.9 Example of (vertical flanking) junction detail in vertical section across supported CLT slab (higher sound insulation, isolation below floor panel)

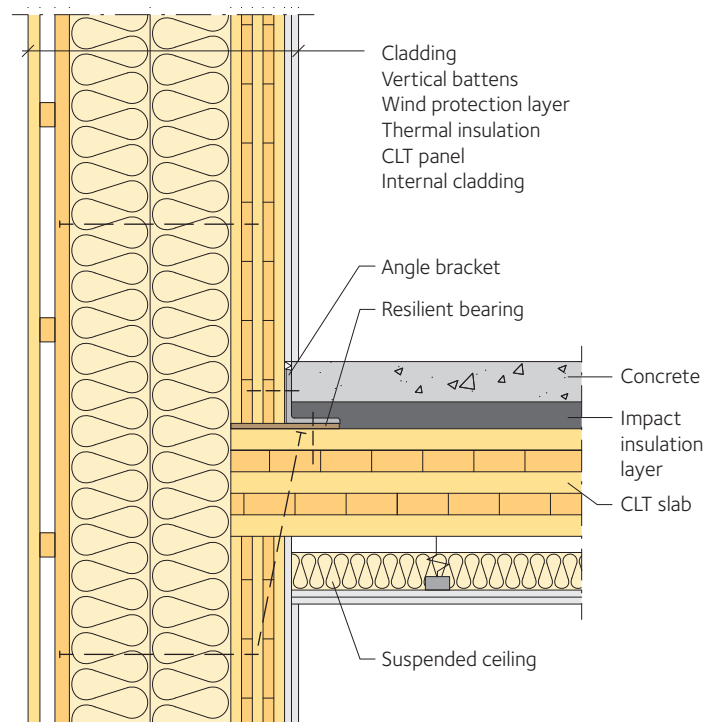

Figure 8.10 Example of (vertical flanking) detail in vertical section across supported CLT slab (higher sound insulation, isolation above floor panel)

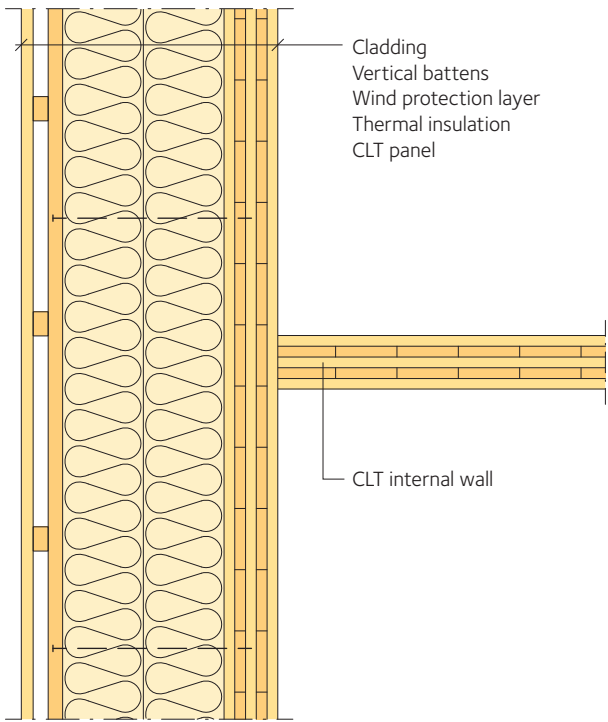

Figure 8.11 Example of (horizontal flanking) junction detail in plan across external CLT wall junction (low sound insulation)

8.5.3 Walls or façades as horizontal flanking elements

Continuous wall or façade sections that extend past junctions with separating walls must also be considered, and the magnitude of flanking is affected by flanking element mass and the presence or absence of flanking wall linings. A discontinuity in the flanking wall is the most effective means of control, and would be expected wherever significant horizontal separation is required.

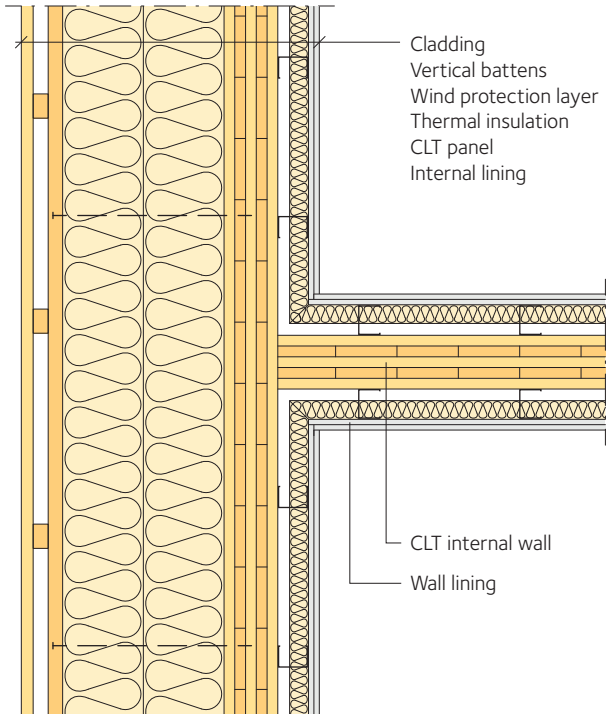

Figure 8.12 Example of (horizontal flanking) junction detail in plan across external CLT wall junction (medium sound insulation)

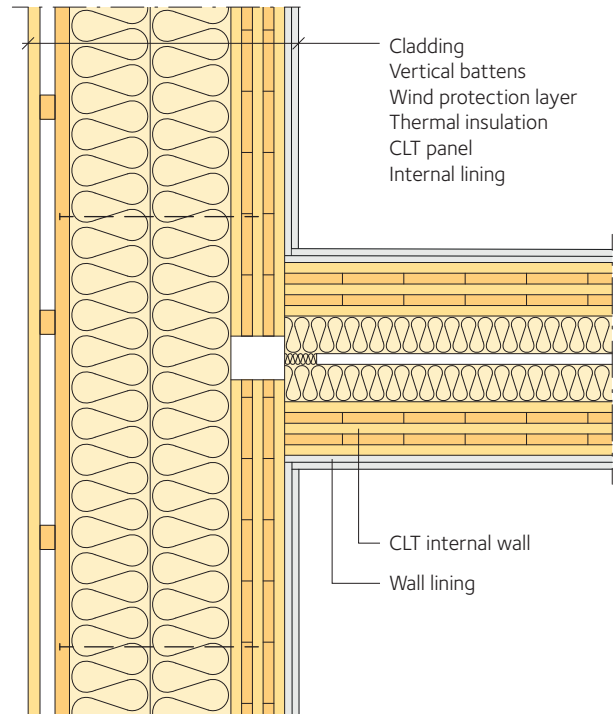

Figure 8.13 Example of (horizontal flanking) junction detail in plan across external CLT wall junction (high sound insulation)

¹⁾ International Organization for Standardization (2013). Acoustics — Rating of sound insulation in buildings and of building elements. Part 1 – Airborne sound insulation (ISO 717-1:2013).

²⁾ International Organization for Standardization (2013). Acoustics — Rating of sound insulation in buildings and of building elements. Part 2 – Impact sound insulation (ISO 717-1:2013).

CLT and thermal comfort

A good indoor climate has a major beneficial impact on a building's occupants. A CLT structure can have many benefits in terms of indoor climate and energy compared to some other forms of construction. For example, the low thermal conductivity of CLT makes the surface of floors and walls pleasant to touch. Since there are few thermal bridges (at least compared to older buildings) and the wooden surfaces do not feel cold, the indoor temperature can generally be lowered by up to a couple of degrees while remaining comfortable. In addition, CLT offers good thermal insulation and a reasonable amount of thermal mass.

- 9.1 Thermal mass 131
- 9.2 Design against condensation 132
- 9.3 Thermal insulation 132

9.1 Thermal mass

Thermal mass can help reduce the amount of energy needed for heating and cooling. The north European climate generally requires a building to be heated to achieve a comfortable indoor climate in winter. When heat is emitted by the occupants, electrical equipment and lighting (for example in offices), cooling can also be needed, especially in the summer when the sun and higher outdoor temperatures heat up the building. If the room surfaces have a higher capacity to store heat (i.e. a higher 'thermal mass'; for example CLT has a higher thermal mass than lightweight timber frame), then the temperature variations will be partially evened out over the course of the day, reducing the amount of energy needed for heating and cooling. As the surfaces of the room cool down, the air in the room is warmed up; conversely, as the building fabric absorbs heat from the air in the room, the air is cooled down. Thermal mass also causes more of the thermal radiation falling on the room surfaces, e.g. from the sun, to be absorbed into the building fabric. In order to take advantage of the benefits of thermal mass to reduce energy use, it is necessary to allow the indoor temperature to fluctuate by a few degrees up and down, to facilitate the flow of heat into and out of the building fabric. By contrast, if the temperature is too closely controlled, the heating will switch on as soon as the temperature falls slightly, and off as soon as the temperature rises, which will lead to greater energy use.

The thermal mass of the building fabric and the benefits of thermal mass, are determined by several factors, such as the building material, method of construction and airtightness. The ideal situation is to store the amount of heat that would otherwise have been lost in the exchange of air. To achieve full benefit from the thermal mass, the building envelope must be both airtight and well insulated to prevent heat from being lost through the walls. As discussed above, ventilation, heating systems and occupant behaviour must also be adapted to make best use of the thermal mass.

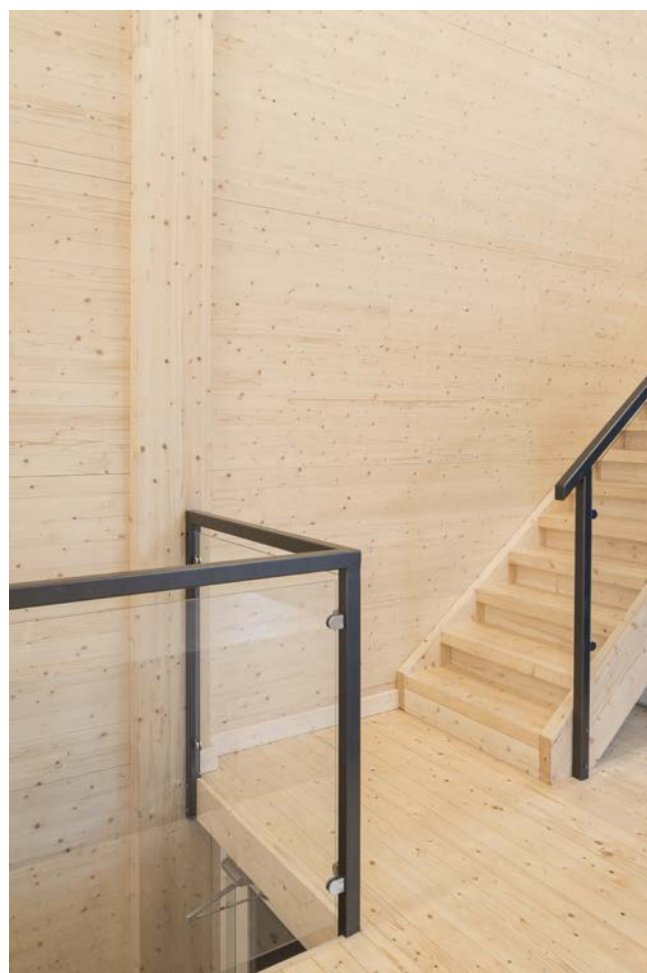

Office building, Ålta, Sweden.

Table 9.1 Typical properties affecting the thermal mass of some common construction materials

Material	Density (kg/m ³)	Specific heat capacity (c) (J/kg K)	Thermal conductivity (W/mK)
CLT	500	1,380	0.1
Mineral wool	10	710	0.04
Plasterboard	800	840	0.2
Brick	1,700	800	0.8
Concrete	2,300	840	2

A material’s thermal mass depends on its density, specific heat capacity and thermal conductivity, see table 9.1. Specific heat capacity is defined as the amount of heat in Joules (J) required to raise the temperature of one kilogram of the material by 1 degree Kelvin. In comparison to some other materials, CLT still offers a reasonable amount of thermal mass per unit volume thanks to its relatively high specific heat capacity, *c*, despite its lower density. However, its thermal mass per unit volume is less than traditional masonry materials such as brick and concrete. The beneficial effects of thermal mass on space temperatures and energy consumption can be quantified using dynamic thermal simulation software.

9.2 Design against condensation

Part of the purpose of an external wall is to maintain a temperature difference between the indoor and outdoor air. However, warmer air holds more water, with the temperature difference leading to the risk of condensation within the build-up of the wall. To avoid this, it is important to have both a vapour barrier (or vapour control layer) on the internal face of the insulation layer (to prevent warm moist internal air seeping through the wall and condensing as it cools) and a breather membrane and ventilated cavity on the external face, to allow moisture to escape by evaporation. Calculations are usually undertaken to assess the specific condensation risks. The aim is either to avoid condensation or at least to ensure that the amount of condensation is small compared to the material’s capacity to store the moisture until it evaporates, thereby avoiding the risk of damage. For example, while a CLT wall has capacity to store moisture, the moisture content in the wood must remain below about 20 % to prevent the risk of fungal decay.

A CLT panel with at least five layers and a thickness of more than 70 mm can often function as an effective vapour barrier (removing the need for an additional vapour barrier), as long as all the joints are sufficiently airtight. However, this would need to be checked by calculation on a case by case basis.

9.3 Thermal insulation

Under steady-state thermal conditions, e.g. on a cold winter’s day when heating is in continuous use, the heat flow through a wall is determined only by its thermal transmittance or *U*-value. The *U*-value is the inverse of the total thermal resistance, *R_T*. A CLT panel has an insulating effect and has few thermal bridges. CLT is usually



Pavilion with curved CLT, Austria.

placed against the warm side, with the flat outer surface providing a good substrate for supplementary layers of insulation. Although wood has good thermal insulation properties, additional insulation is required to comply with the Building Regulations.

The U -value states how much heat flows through 1 m² of wall for a temperature difference of 1 K between the warm and the cold side.

The thermal conductivity of wood depends on the wood's density and moisture content. For kiln-dried softwood with a moisture content of around 12 %, the thermal conductivity, also known as the lambda value, $\lambda = 0.10 - 0.12$ W/mK, which is about three times the value for mineral wool insulation.

To determine a structure's U -value, the following process can be used:

- Determine the thermal conductivity, λ , of all the constituent materials, from product datasheets, handbooks or codes.
- Determine the thermal resistance, R , of the air gaps and the surface resistance values, R_{si} and R_{se} . BS-EN ISO 6946: 2017 differentiates between three different types of air gap, see table 9.2, page 134.
- Determine the correction factors, ΔU , for fixings, gaps etc, see table 9.4, page 134.

where:

ΔU_f is a correction factor for the extra heat flow due to small fixings in the structure. This is usually negligible, particularly for timber structures.

ΔU_g is a correction factor that takes account of construction tolerances.

- Calculate the thermal transmittance coefficient for the entire building.

If the envelope only comprises homogeneous layers, the thermal resistance of each layer can be calculated and then added together, after which the U -value can be calculated using equations 9.1 – 9.3:

$$R_i = \frac{d_i}{\lambda_i} \quad \text{m}^2\text{K/W} \quad 9.1$$

where R_i , d_i and λ_i are the thermal resistance, thickness and thermal conductivity of layer i .

$$R_T = R_{si} + R_1 + R_2 + \dots R_n + R_{se} \quad \text{m}^2\text{K/W} \quad 9.2$$

$$U = \frac{1}{R_T} + \Delta U_g + \Delta U_f \quad \text{W/m}^2\text{K} \quad 9.3$$

When calculating the U -value for a build-up that has non-homogeneous layers, such as studs in an insulation layer, there are two ways to calculate the thermal transmittance coefficient according to BS-EN 6946: the U -value method and the λ -value method. The calculations give a lower and an upper bound value for the total thermal resistance, R_T . The thermal resistance used to calculate the U -value is then the average value of the two thermal resistance figures obtained previously.

Weighting under the U -value method uses areas perpendicular to the heat flow, while under the λ -value method the weighting produces a new λ -value for each non-homogeneous layer. An illustration of the two methods is given in the following example.



Insulation of CLT wall.

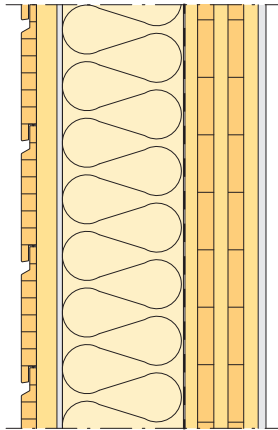

Figure 9.1 Cross-section of external wall

Example:

A wall with the following build-up: 13 mm plasterboard, 100 mm CLT, vapour barrier, 170 mm sheet insulation with 12 percent timber studs by area, breather membrane, 34 mm air gap, horizontal glulam cladding (the air gap and cladding are not included in the U -value calculations), see figure 9.1.

Using the U -value method

The total thermal resistance of the build-up is first calculated using each of the two methods separately. Weighting under the U -value method uses areas perpendicular to the heat flow. In this case, we only have two areas in the non-homogeneous layer – timber studs and insulation.

$$A_1 = 0.12 \quad \text{m}^2$$

$$A_2 = 0.88 \quad \text{m}^2$$

Four U -values are calculated, and the process begins by totalling up the resistances for the two cases. The thermal resistance figures for the plasterboard and the CLT panel are always included, plus the two surface resistance figures, see table 9.3, added together:

$$R = \frac{d_1}{\lambda_{\text{gypsum}}} + \frac{d_2}{\lambda_{\text{timber}}} + R_{\text{si}} + R_{\text{se}}$$

$$= \frac{0.013}{0.25} + \frac{0.100}{0.14} + 0.13 + 0.040 = 0.991 \quad \text{m}^2\text{K/W}$$

Table 9.2 Thermal resistance of different air gaps

Air gap	Thermal resistance, R (m ² K/W)
Unventilated air gaps	< 0.18
Poorly ventilated air gaps	< 0.15
Well ventilated air gaps	0

Case 1: Area A_1 , timber studs:

$$R_1 = R + \frac{d_3}{\lambda_{\text{timber}}} = 0.991 + \frac{0.170}{0.14} = 2.205 \quad \text{m}^2\text{K/W}$$

$$U_1 = \frac{1}{2.205} = 0.454 \quad \text{W/m}^2\text{K}$$

Case 2: Area A_2 , sheet insulation:

$$R_2 = R + \frac{d_3}{\lambda_{\text{insulation}}} = 0.991 + \frac{0.170}{0.14} = 2.205 \quad \text{m}^2\text{K/W}$$

$$U_2 = \frac{1}{5.586} = 0.179 \quad \text{W/m}^2\text{K}$$

The U -values are weighted together based on the areas:

$$U_u = 0.12 \times 0.454 + 0.88 \times 0.179 = 0.212 \quad \text{W/m}^2\text{K}$$

which gives:

$$R_u = \frac{1}{0.212} = 4.717 \quad \text{m}^2\text{K/W}$$

Table 9.3 Surface resistance of various building components

Building component	Internal surface resistance, R_{si} (m ² K/W)	External surface resistance, R_{se} (m ² K/W)
Walls	0.13	0.04
Ceiling	0.10	0.04
Floor	0.17	0.04

Table 9.4 Examples of correction factors for external walls

Building component	ΔU (W/m ² K)
External wall with an insulating layer with studs	0.01
External wall with intersecting studs	0



Architects' office, London, England.

Using the λ -value method

In the λ -value method, a new weighted λ -value is calculated for each non-homogeneous layer. The proportion of wood in the non-homogeneous layer is 0.12 and of insulation 0.88:

$$\lambda = 0.12 \times 0.14 + 0.88 \times 0.037 = 0.0494 \quad \text{W/m}^2\text{K}$$

The R -value is thus:

$$R_{\lambda} = 0.991 + \frac{0.170}{0.0494} = 4.432 \quad \text{m}^2\text{K/W}$$

The average value for the two methods gives:

$$R_T = \frac{(R_u + R_{\lambda})}{2} = \frac{(4.717 + 4.432)}{2} = 4.5745 \quad \text{m}^2\text{K/W}$$

And then the U -value comes out as:

$$U = \frac{1}{R_T} = 0.223 \quad \text{W/m}^2\text{K}$$

Procurement and site works

- 10.1 Procurement 136
- 10.2 Preventing moisture damage during construction 136
 - 10.2.1 Storage 137
 - 10.2.2 Preventing long-term structural damage 137
 - 10.2.3 Preventing damage to the visual appearance of the CLT 138
 - 10.2.4 Moisture content control plan 138
 - 10.2.5 Method of measuring moisture content 139
- 10.3 Delivery, lifting and temporary stability 139
 - 10.3.1 Delivery 139
 - 10.3.2 Lifting 140
 - 10.3.3 Temporary stability 141

10.1 Procurement

The tender information should contain all the relevant information that the CLT supplier needs in order to provide a complete tender price. In addition to the price, questions about the material’s strength class and appearance grade, type of glue and/or charring rate, dimensions and tolerance, cutting and machining (bearing in mind that service openings etc. need to be factory cut), programme, target moisture content and so on have to be answered. If you want the supplier to be involved in the design work (which is the most common route in the UK), this should be made clear in the tender. Unlike steel (where the members and connections are usually designed by different parties), it is recommended that the same engineer is responsible for both the sizing of the CLT panels and the design of the connections; this is because the CLT panel thickness will sometimes be governed by the connections. Since the in-situ concrete substructure will have much lower tolerances than the CLT, this needs to be taken account of in the design and detailing of the CLT.

10.2 Preventing moisture damage during construction

An important question on all building projects is how to handle weather protection during construction, and how to avoid the risk of future damage caused by moisture. In the case of CLT, the moisture content needs to be kept below about 18 % at all times, to prevent the risk of long-term structural damage due to decay or delamination. In addition, if the CLT is to be visually exposed in the finished building,

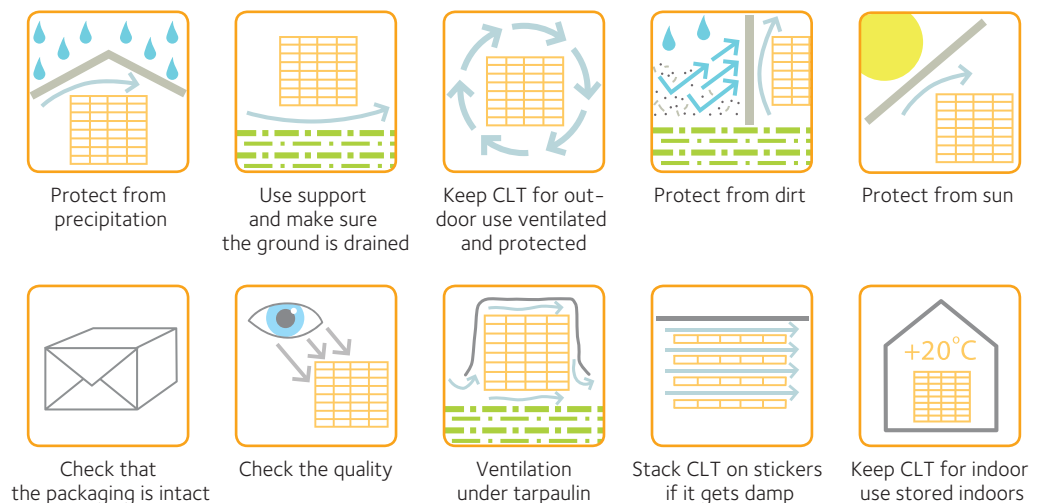

Figure 10.1 A few key principles for protecting CLT products

then additional care is required to prevent visual damage due to water staining. The question of how to protect the CLT during construction should therefore be given high priority in planning the site works, *see figure 10.1, page 136*. Some of the measures to prevent problems, such as providing upstands under walls, and providing falls and permanent ventilation to roofs, need to be incorporated at design stage.

10.2.1 Storage

- CLT normally has a moisture content of no more than 16 % on delivery from the manufacturer.
- CLT panels or complete structural units are usually transported in protective wrap. If the packaging is fully sealed, the products can be stored outside under a tarpaulin for a short time. If the packaging is broken (even minor tears), it should be repaired or removed completely, and the CLT should continue to be stored in a dry and warm place if it will be used indoors.
- CLT that will be used in unheated buildings or in an outdoor climate, protected under a roof, can be stored in a cold area, well protected from rainfall.
- Make sure the storage location is in the shade in spring, summer and autumn. Sunlight makes the surfaces of packaged CLT hotter than the ambient temperature, which can lead to splitting or condensation, which in turn increases the risk of microbial growth.
- Rest the CLT on clean dry supports, at least 300 mm off the ground or the floor, to provide good ventilation. Make sure you have enough supports to stop the CLT panels bending.
- Do not place CLT panels where there is a risk of soiling and splashing from guttering or traffic, for example.

10.2.2 Preventing long-term structural damage

To prevent long-term structural damage due to decay or delamination or drying shrinkage (and also to avoid invalidating the manufacturer's warranty), the moisture content of the CLT must be kept below about 18 % at all times during construction. If any water is allowed to pool on the CLT, even for a short time, it will soak in, leading to higher moisture contents than 18 %. Exposed end-grain (at the edges of panels and around openings) is particularly susceptible, as it soaks up water fast. Examples of measures that can be used to prevent excessive wetting of the CLT are as follows:

- Plan the times of deliveries carefully to minimise or avoid storage time on site.
- Store carefully, *see section 10.2.1*.
- Weather protect the building as fast as possible after erection of the CLT.
- At the base of the building, place the CLT walls on upstands to avoid the risk of them sitting in a pool of water.
- Ensure water cannot pond on the CLT (e.g. lay CLT roofs to falls, provide drainage holes at low points, sweep standing water off floor surfaces as soon as possible).
- Avoid water traps (e.g. tape panel-to-panel joints to prevent water becoming trapped between panels; ensure that any rebates in the surface of the CLT, such as lifting points, have drainage holes).
- Protect all exposed end-grain with an end-grain sealant.
- Consider detailing the CLT with ventilation to both faces, so that any trapped moisture can quickly escape.



Elevator shaft of CLT.



Assembly of summer house, Skellefteå, Sweden.

10.2.3 Preventing damage to the visual appearance of the CLT

Visual damage can occur due to staining and also due to surface shrinkage and fissuring following wetting. Measures that can help prevent this are:

- Prevent wetting of the exposed CLT surfaces.
- Apply a clear surface sealer to protect the surfaces from dirt and splashes.
- Apply an end-grain sealant to the edges of the CLT panels to prevent water soaking along the end-grain.
- Tape the joints between floor panels.

The appearance of the CLT can also be affected by mould growth. The risk of mould growth can begin at around 75 % relative humidity if it is very warm. At low temperatures, the relative humidity can be much higher. Mould grows on the surface of wood and does not affect its strength. Soiled wood is more likely to see mould growth, since dirt often contains both spores and nutrients. The humidity level is not the only factor that affects mould growth; nutrients in the surface, temperature, pH, UV light, time and the number of spores also play a role. Mould growth can be a precursor to other, more serious attacks.

10.2.4 Moisture content control plan

A moisture content control plan should be prepared to show how the moisture content of the CLT will be controlled and monitored during construction. This should include:

- The target equilibrium moisture content during fabrication, erection and in service.
- The critical moisture content for decay.
- The need to ensure that detrimental swelling, shrinkage or decay of the CLT panels is avoided.
- Before being used in construction, the CLT should be dried as near as practicable to the moisture content appropriate to its equilibrium moisture content corresponding to the conditions in service.
- The risk of wetting and water traps during transport and erection.
- How moisture content will be controlled.
- The need for controlled drying after erection.
- Storage methods.
- Whether any protection is needed during transport, storage and erection.
- The need to ensure that the protection etc. for durability is in accordance with the drawings.
- How moisture content will be measured, including the methods of measurement; whether it will be measured at depth (if ponding is allowed on CLT, water can easily penetrate to the 2nd and 3rd lamellas), when it will be measured and how the readings will be assessed. Concentrate on areas with the greatest risk of moisture absorption and the poorest drying conditions.
- If the target moisture content is exceeded, but not the critical moisture content, the element should be dried out and a new moisture check carried out before encasing.

- If elements are to be encased, then carefully check the moisture content beforehand.
- If the critical moisture content for decay is exceeded, a damage check should be carried out and any moisture damage rectified.

10.2.5 Method of measuring moisture content

It is not possible to check by touch whether wood is dry; the surface of damp wood can still feel dry to the touch. The most common way to check moisture content is to use an electrical resistance moisture meter with insulated hammer electrodes, *see figure 10.2*. The procedure is as follows:

- Check that the meter is calibrated using a calibration block.
- Measure the temperature of the wood with the integral temperature sensor or estimate the temperature with a separate thermometer.
- The temperature settings on the meter can then be set to the temperature of the wood. If the instrument does not compensate for temperature, the measurement value must be adjusted afterwards.
- Select the correct wood species.
- Check the moisture content by inserting the electrodes to the required measurement depth. Avoid measuring close to a layer of adhesive. It is recommended to measure around 20 mm up the wall unit, so as not to be measuring the end-grain wood. If the moisture content is higher than the desired level, regular checks should be carried out during drying until the desired moisture content is achieved.

Note that an electrical resistance moisture meter cannot measure moisture contents above the fibre saturation point (30 %). Low moisture contents, such as 6 – 8 %, can also be difficult to measure. The measurement error is about ± 2 %. Generally measurements are taken at several depths in one measuring point, by drilling progressively deeper and using insulated probes, to check the moisture content of at least the top two lamellas.

10.3 Delivery, lifting and temporary stability

10.3.1 Delivery

CLT panels have relatively low self-weight and their compact form makes them easy to load, transport and unload efficiently. It is important that the panels are loaded in the right order, so they can then be unloaded in the order that they will be assembled. Each panel should be clearly labelled, so that it can be easily tracked on the assembly plan. The CLT supplier should be given clear details about the order of assembly.

Measuring average moisture content of CLT – resistance method.

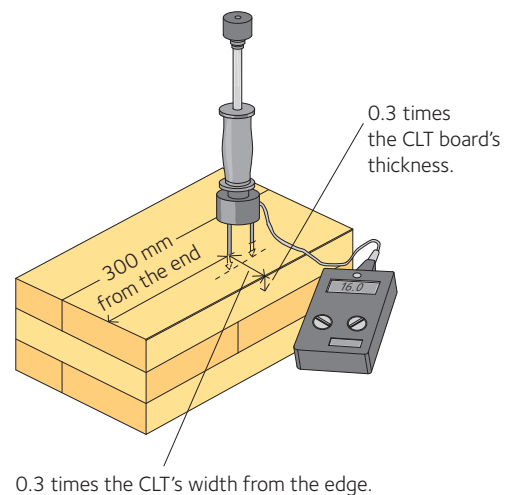
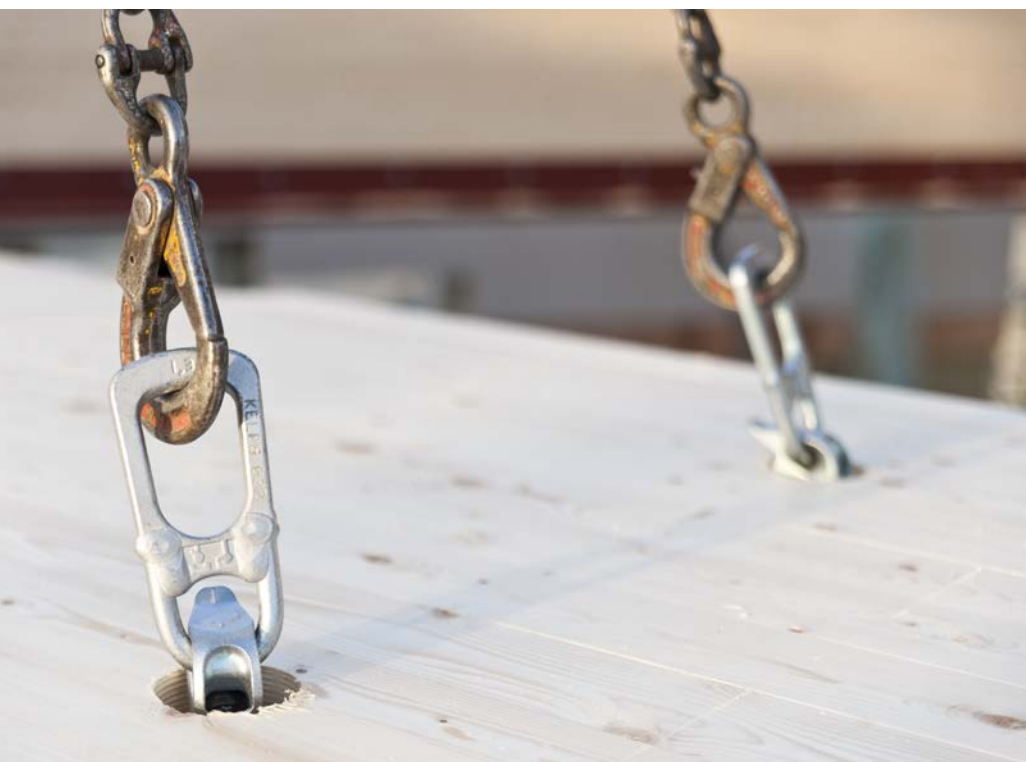

Figure 10.2 Measuring the average moisture content of the top lamella with a hammer probe. To check the moisture content of the 2nd and 3rd lamellas it is necessary to drill holes and use long insulated probes.



Wall units ready for delivery.



Spherical head lifting anchors fixed with wood screws.



Lifting a prefabricated wall unit.

10.3.2 Lifting

There are important safety issues to consider when assembling the panels. It is, for example, vital that wall units are quickly anchored and braced.

A number of different methods are available for lifting and handling CLT panels. Various types of webbing slings, steel wire ropes and steel chains are commonly used. Floor and wall panels are usually lifted with the help of special eyes and lifting yokes. The lifting equipment must be designed so that all the loads are statically determinate, see *figure 10.3*. This is to ensure an even distribution of the load across all the lifting points. The particular CLT supplier will usually have a standard method that they use for lifting, which can determine the number of lifting points and so on.

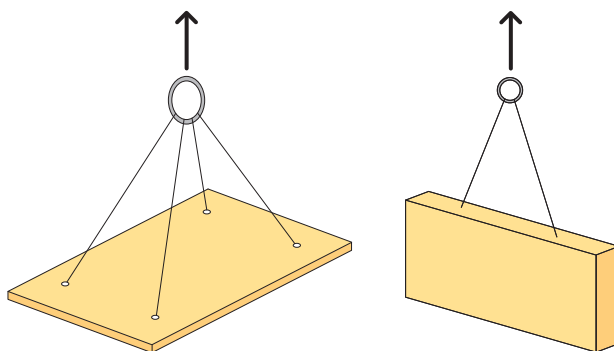

Figure 10.3 Example of a statically determinate system for handling floor and wall panels



Assembly of CLT floor.



Stabilising using braces during construction.

Using bolts and load-distributing washers is seen as the safest way to make lifting points in a floor slab. Bolts do, however, penetrate the surface, and if that surface is intended to be left exposed, the holes will need filling afterwards. The holes also need filling to ensure compliance with sound, waterproofing and fire safety requirements. Another common method is to use spherical head lifting anchors, which are fixed in place with wood screws, *see figure 10.4*.

For walls, simple slings are usually threaded through holes made in the CLT panel. Once the unit is fixed in place, the sling can then easily be removed. Walls commonly come with two or four lifting points, depending on the weight and shape of the unit. Wall units with two lifting points should be lifted using a two-leg chain sling with safety hooks. Wall units with four points should be lifted with four safety hooks and wire ropes. When assembling large units, wind conditions should be taken into account, with wall panels usually considered to be thin and unstable when their length exceeds 8 – 10 m.

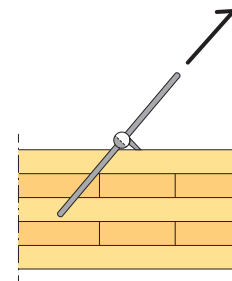

Figure 10.4 Diagram of a spherical head-lifting anchor with an angled lifting screw

10.3.3 Temporary stability

The walls and floor structures are normally used to stabilise the frame. Therefore, temporary braces are often needed until the next floor is in place.

The connections between walls and floors have to not only hold the structural components in place but also to transfer large horizontal and vertical loads. The anchors are normally slightly pre-stressed to compensate for the long-term settlement that occurs over the course of construction. Once the building is complete, it is therefore essential to check that the anchors are still under tension and not loose.

Symbols

Symbol	Explanation
Latin upper case letters	
A	Cross-sectional area
A_{ef}	Effective area of contact surface between a nail plate and the underlying wood; effective contact area with force perpendicular to the grain
A_f	Cross-sectional area of a flange
$A_{net,t}$	Net cross-sectional area perpendicular to the grain
$A_{net,v}$	Net shear area parallel with the grain
C	Spring constant
$E_{0,05}$	Modulus of elasticity, 5 percent fractile
E_d	Modulus of elasticity, design value
E_{mean}	Modulus of elasticity, mean value
$E_{mean,fn}$	Modulus of elasticity, final mean value
F	Force
$F_{A,Ed}$	Design force on a nail plate acting in the centre of gravity of the effective area
$F_{A,min,d}$	Minimum design force on a nail plate acting in the centre of gravity of the effective area
$F_{ax,Ed}$	Design axial force on a fastener
$F_{ax,Rd}$	Design value of the axial withdrawal capacity of the fastener
$F_{ax,Rk}$	Characteristic axial withdrawal capacity of the fastener
F_c	Compressive action or force
F_d	Design value of a force
$F_{d,ser}$	Design force at the serviceability limit state
$F_{f,Rd}$	Design load capacity per fastener in a wall unit
$F_{i,c,Ed}$	Design compressive reaction force at the end of a wall panel
$F_{i,t,Ed}$	Design tensile reaction force at the end of a wall panel
$F_{i,vert,Ed}$	Vertical load on a wall
$F_{i,v,Rd}$	Design resistance under diaphragm action for constituent component i or wall i
F_{la}	Transverse load
$F_{M,Ed}$	Design force from a design moment
F_t	Tensile force
$F_{t,Rk}$	Characteristic value for tensile load capacity of a connection
$F_{v,0,Rk}$	Characteristic load capacity of a screw with washer along the grain
$F_{v,Ed}$	Design shear force per shear plane of fastener; horizontal design effect on a wall panel
$F_{v,Rd}$	Design shear load capacity per shear plane for a fastener; design shear load capacity
$F_{v,Rk}$	Characteristic shear load capacity per shear plane for a fastener

$F_{v,w,Ed}$	Design shear force on web
$F_{x,Ed}$	Design value of a force in the x-direction
$F_{y,Ed}$	Design value of a force in the y-direction
$F_{x,Rd}$	Design value of a plate's load capacity in the x-direction
$F_{y,Rd}$	Design value of a plate's load capacity in the y-direction
$F_{x,Rk}$	The plate's characteristic load capacity in the x-direction
$F_{y,Rk}$	The plate's characteristic load capacity in the y-direction
$G_{0,05}$	Shear modulus, 5 percent fractile
G_d	Shear modulus, design value
G_{mean}	Shear modulus, mean value
H	Total height of a roof truss
I_f	Moment of inertia of a flange
I_{tor}	Torsional moment of inertia
I_z	Torsional moment of inertia about the weaker axis
K_{ser}	Slip modulus
$K_{ser,fn}$	Slip modulus at the final condition
K_u	Slip modulus for the ultimate limit state at the instantaneous condition
$L_{net,t}$	Net width of cross-sectional area perpendicular to the grain
$L_{net,v}$	Net length of failure area under shear stress
$M_{A,Ed}$	Design moment
$M_{ap,d}$	Design moment in the apex zone
M_d	Design moment
$M_{y,Rk}$	Characteristic yield moment of fastener
N	Axial force
$R_{90,d}$	Design splitting capacity
$R_{90,k}$	Characteristic splitting capacity
$R_{ax,d}$	Design load capacity of an axially loaded connection
$R_{ax,k}$	Characteristic load capacity of an axially loaded connection
$R_{ax,\alpha,k}$	Characteristic load capacity at an angle α to the grain
R_d	Design value of load capacity
$R_{ef,k}$	Effective characteristic load capacity of a connection
$R_{iv,d}$	Design shear load capacity of a wall
R_k	Characteristic load capacity
$R_{sp,k}$	Characteristic splitting capacity
$R_{to,k}$	Characteristic load capacity of a serrated washer
$R_{v,d}$	Design shear load capacity of a wall
V	Shear force; volume

V_u, V_l	Shear forces in the upper and lower part of a beam with a hole
W_y	Moment of resistance about the y-axis
X_d	Design value of a material strength property
X_k	Characteristic value of a material strength property
Latin lower case letters	
a	Distance
a_1	Spacing, parallel to the grain, of fasteners within one row
$a_{1,CG}$	Minimum end distance to centre of gravity for wood screws in each section of timber
a_2	Spacing, perpendicular to the grain, between rows of fasteners
$a_{2,CG}$	Minimum edge distance to centre of gravity for wood screws in each section of timber
$a_{3,c}$	Distance between fasteners and an unloaded end
$a_{3,t}$	Distance between fasteners and a loaded end
$a_{4,c}$	Distance between fasteners and an unloaded edge
$a_{4,t}$	Distance between fasteners and a loaded edge
a_{bow}	Maximum initial bow imperfection in a section of timber in a truss
$a_{bow,perm}$	Maximum permitted bow imperfection in a section of timber in a truss
a_{dev}	Maximum positional deviation for a truss
$a_{dev,perm}$	Maximum permitted positional deviation for a truss
b	Width
b_i	Width of panel i or wall i
b_{net}	Clear distance between studs
b_w	Web width
d	Diameter; outer diameter of thread
d_1	Diameter of centre hole of a washer; inner diameter of thread
d_c	Washer diameter
d_{ef}	Effective diameter
d_h	Connector's head diameter
$f_{h,i,k}$	Characteristic embedment strength of timber member i
$f_{a,0,0}$	Characteristic anchorage strength per surface unit for $\alpha = 0^\circ$ and $\beta = 0^\circ$
$f_{a,90,90}$	Characteristic anchorage strength per surface unit for $\alpha = 90^\circ$ and $\beta = 90^\circ$
$f_{a,\alpha,\beta,k}$	Characteristic anchorage strength
$f_{ax,k}$	Characteristic withdrawal strength for the point of a nail; characteristic withdrawal strength
$f_{c,0,d}$	Design compressive strength along the grain
$f_{c,w,d}$	Design compressive strength of a web
$f_{f,c,d}$	Design compressive strength of a flange
$f_{c,90,k}$	Characteristic compressive strength perpendicular to the grain
$f_{f,t,d}$	Design tensile strength of a flange

$f_{h,k}$	Characteristic embedment strength
$f_{head,k}$	Characteristic pull-through strength of fastener
f_1	Fundamental frequency
$f_{m,k}$	Characteristic bending strength
$f_{m,y,d}$	Design bending strength about the principal y-axis
$f_{m,z,d}$	Design bending strength about the principal z-axis
$f_{m,\alpha,d}$	Design bending strength at an angle α to the grain
$f_{t,0,d}$	Design tensile strength along the grain
$f_{t,0,k}$	Characteristic tensile strength along the grain
$f_{t,90,d}$	Design tensile strength perpendicular to the grain
$f_{t,w,d}$	Design tensile strength of the web
$f_{u,k}$	Characteristic tensile strength of screw
$f_{v,0,d}$	Design panel shear strength
$f_{v,\alpha,\alpha,k}$	Characteristic withdrawal strength at an angle α to the grain
$f_{v,\alpha,90,k}$	Characteristic withdrawal strength perpendicular to the grain
$f_{v,d}$	Design shear strength
h	Height; wall height
h_{ap}	Height of the apex zone
h_d	Hole depth
h_e	Embedment depth; distance to loaded edge
h_{ef}	Effective height
$h_{f,c}$	Height of compression flange
$h_{f,t}$	Height of tension flange
h_{fl}	Distance from lower edge of hole to lower edge of component
h_{fu}	Distance from upper edge of hole to upper edge of component
h_w	Web height
i	Notch inclination
$k_{c,y}, k_{c,z}$	Instability factor
k_{cr}	Cracking factor for shear load capacity
k_{crit}	Factor used for lateral buckling
k_d	Dimension factor for a panel
k_{def}	Deformation factor
k_{dis}	Factor for taking account of the stress distribution in an apex zone
$k_{f,1}, k_{f,2}, k_{f,3}$	Correction factors for bracing resistance
k_h	Height factor
$k_{i,q}$	Uniformly distributed load factor
k_m	Factor for the redistribution of bending stresses in a cross-section
k_{mod}	Factor for duration of load and moisture content
k_n	Factor for wall cladding
k_r	Reduction factor

$k_{R,red}$	Reduction factor for load capacity
k_s	Fastener spacing factor; correction factor for spring constant
$k_{s,red}$	Reduction factor for mutual spacing
k_{shape}	Factor depending on the shape of the cross-section
k_{sys}	System strength factor
k_v	Reduction factor for notched beams
k_{vol}	Volume factor
k_y eller k_z	Instability factor
$l_{a,min}$	Minimum anchor length for a glued-in rod
l, L	Span; contact length
l_A	Distance from a hole to the centre line of the component support
l_{ef}	Effective length; effective distribution length
l_V	Distance from a hole to the end of the component
l_z	Centre spacing between holes
m	Mass per unit area
n_{40}	Number of frequencies below 40 Hz
n_{ef}	Effective number of fasteners
p_d	Distributed load
q_i	Equivalent uniformly distributed load
r	Radius of curvature
s	Spacing
s_0	Basic fastener spacing
r_{in}	Inner radius of a curve
t	Thickness
t_{pen}	Penetration depth
u_{creep}	Creep deformation
u_{fin}	Final deformation
$u_{fin,G}$	Final deformation for a permanent action G
$u_{fin,Q,1}$	Final deformation for a leading variable action Q_1
$u_{fin,Q,i}$	Final deformation for accompanying variable actions Q_i
u_{inst}	Instantaneous deformation
$u_{inst,G}$	Instantaneous deformation for a permanent action G
$u_{inst,Q,1}$	Instantaneous deformation for a leading variable action Q_1
$u_{inst,Q,i}$	Instantaneous deformation for accompanying variable actions Q_i
w_c	Pre-camber
w_{creep}	Creep deflection
w_{fin}	Final deflection
w_{inst}	Instantaneous deflection
$w_{net,fin}$	Net final deflection
v	Unit impulse velocity response

Greek lower case letters	
α	Angle between x-direction and force in a nail plate; angle between force and grain; angle between load and edge (or ends) subject to load
β	Angle between grain and force for a nail plate
β_c	Straightness factor
γ	Angle between the x-direction for a nail plate and the main direction of the wooden
γ_M	Partial factor for material properties also accounting for model uncertainties and dimensional variations
λ_y	Slenderness ratio for bending about the y-axis
λ_z	Slenderness ratio for bending about the z-axis
$\lambda_{rel,y}$	Relative slenderness ratio for bending about the y-axis
$\lambda_{rel,z}$	Relative slenderness ratio for bending about the z-axis
ρ_k	Characteristic density
ρ_m	Mean density
$\sigma_{c,0,d}$	Design compressive stress along the grain
$\sigma_{c,\alpha,d}$	Design compressive stress at an angle α to the grain
$\sigma_{f,c,d}$	Mean design compressive stress in a flange
$\sigma_{f,c,max,d}$	Design compressive stress of the extreme fibres in a flange
$\sigma_{f,t,d}$	Mean design tensile stress in a flange
$\sigma_{f,t,max,d}$	Design tensile strength of the extreme fibres in a flange
$\sigma_{m,crit}$	Critical bending stress
$\sigma_{m,y,d}$	Design bending stress about the principal y-axis
$\sigma_{m,z,d}$	Design bending stress about the principal z-axis
$\sigma_{m,\alpha,d}$	Design bending stress at an angle α to the grain
σ_N	Normal stress
$\sigma_{t,0,d}$	Design tensile stress along the grain
$\sigma_{t,90,d}$	Design tensile stress perpendicular to the grain
$\sigma_{w,c,d}$	Design compressive stress in a web
$\sigma_{w,t,d}$	Design tensile stress in a web
τ_d	Design shear stress
$\tau_{F,d}$	Design anchor stress, axial force
$\tau_{M,d}$	Design anchor stress, moment
$\tau_{tor,d}$	Design torsional shear stress
ψ_0	Factor for the combination value of variable actions
ψ_1	Factor for the frequent value of a variable action
ψ_2	Factor for the quasi-permanent value of a variable action
ζ	Relative damping

CLT-specific	
$A_{x,net}$	Net cross-sectional area normal, x-axis
$A_{y,net}$	Net cross-sectional area normal, y-axis
$f_{c,0,x,k}$	Characteristic compressive strength of panel along x-axis.
$f_{c,0,y,k}$	Characteristic compressive strength of panel along y-axis.
$f_{c,90,xy,k}$	Characteristic compressive strength perpendicular to the plane of the panel
$G_{R,mean}$	Rolling shear modulus, mean value
$f_{m,x,k}$	Characteristic bending strength of CLT panel in global x-direction.
$f_{m,y,k}$	Characteristic bending strength of CLT panel in global y-direction.
$f_{t,0,x,k}$	Characteristic tensile strength of panel in global x-direction.
$f_{t,0,y,k}$	Characteristic tensile strength of panel in global y-direction.
$f_{t,90,x,k}$ $f_{t,90,y,k}$	Characteristic tensile strength perpendicular to the plane of the panel
$f_{c,0,xlay,k}$	Characteristic compressive strength along the grain for boards in the global x-direction.
$f_{c,0,ylay,k}$	Characteristic compressive strength along the grain for boards in the global y-direction.
$f_{c,90,xlay,k}$	Characteristic compressive strength perpendicular to the grain for boards in the global x-direction.
$f_{c,90,ylay,k}$	Characteristic compressive strength perpendicular to the grain for boards in the global y-direction.
$f_{m,xlay,k}$	Characteristic bending strength for boards in the global x-direction.
$f_{m,ylay,k}$	Characteristic bending strength for boards in the global y-direction.
$f_{t,0,xlay,k}$	Characteristic tensile strength for boards in the global x-direction.
$f_{t,0,ylay,k}$	Characteristic tensile strength for boards in the global y-direction.
$f_{v,090,xlay,k}$	Characteristic shear strength for longitudinal boards in the x-direction
$f_{v,090,ylay,k}$	Characteristic shear strength for longitudinal boards in the y-direction
$f_{v,9090,xlay,k}$	Characteristic shear strength for transverse boards in the x-direction
$f_{v,9090,ylay,k}$	Characteristic shear strength for transverse boards in the y-direction
$E_{0,x,mean}$	Mean modulus of elasticity for a panel in the global x-direction

$E_{90,x,mean}$	Mean modulus of elasticity for a panel perpendicular to the global x-direction
$E_{0,y,mean}$	Mean modulus of elasticity for a panel in the global y-direction
$E_{90,y,mean}$	Mean modulus of elasticity for a panel perpendicular to the global y-direction
$E_{0,x,0,05}$	Modulus of elasticity's 5 percent fractile for a panel in the global x-direction
$E_{0,y,0,05}$	Modulus of elasticity's 5 percent fractile for a panel in the global y-direction
$G_{090,xlay,mean}$	Mean shear modulus along boards in the global x-direction
$G_{090,ylay,mean}$	Mean shear modulus along boards in the global y-direction
$G_{9090,xlay,mean}$	Mean shear modulus along boards in the global x-direction (rolling shear modulus)
$G_{9090,ylay,mean}$	Mean shear modulus along boards in the global y-direction (rolling shear modulus)
$I_{t,0,CLT}$	Torsional moment of inertia about the x-axis
$I_{t,90,CLT}$	Torsional moment of inertia about the y-axis
$I_{x,net}$	Net moment of inertia for deflection about the y-axis
$I_{y,net}$	Net moment of inertia for deflection about the x-axis
$I_{x,ef}$	Effective moment of inertia for deflection about the y-axis
$I_{y,ef}$	Effective moment of inertia for deflection about the x-axis
$i_{x,ef}$	Effective radius of gyration for deflection about the y-axis
$i_{y,ef}$	Effective radius of gyration for deflection about the x-axis
κ_x	Shear correction factor equating to deflection about the y-axis
κ_y	Shear correction factor equating to deflection about the x-axis
$S_{x,net}$	Net static moment or net shear resistance
$S_{y,net}$	Net static moment or net shear resistance

Bibliography

General

BSP handbuch, Holz-Massivbauweise in Brettsperrholz, 2010.

CLT handbook, FP Innovation, Canada, 2011.

Focus Solid Timber Solutions – European Conference on Cross Laminated Timber, Graz, 2013.

Handbok – Bygge med Massivtreelement, Norsk Treteknisk Institutt, 2007.

Massivträ. Handboken, Industrikonsortiet Massivträ, 2002.

Wallner-Novak M., Koppelhuber J, Pock K. Cross-Laminated Timber Structural Design, Basic design and engineering principles according to Eurocode, pro:Holz, 2014.

Chapter 1 – CLT as a construction material

Eriksson P. Comparative LCAs for wood and other construction methods, Proceedings of the 8th WCTE, Lahti, Finland, 2004.

Gustafsson A, Eriksson P-E, Engström S, Wik T, Serrano E. Handbok för beställare och projektörer av flervånings bostadshus i trä. SP report 2012:70, 2013.

Peñaloza D, Norén J, Eriksson P. Life Cycle Assessment of Different Building Systems: The Wälluden Case Study, SP Report 2013:07, 2013.

Chapters 2 and 3 – Basis of design of CLT structures/Design of CLT structures

Betjka I, Lam F. Cross laminated timber as innovative building material. Proceedings of the CSCE Annual Conference in Quebec, Canadian Society for Civil Engineering, 2008.

Bogensperger T, Moosbrugger T & Silly G. Verification of CLT-plates under loads in plane. WCTE 2010.

Fellmoser P, Blass H.J. Influence of rolling shear modulus on strength and stiffness of structural bonded timber elements. In Proceeding of CIB-W18 Meeting, Edinburgh, 2004.

Flaig M, Blass H J. Shear strength and shear stiffness of CLT-beams loaded in plane. CIB 2013.

Jeleč M, Danielsson H, Serrano H, Rajčić V, Cross laminated timber at in-plane beam loading – New analytical model predictions and relation to EC5, 2018.

Schickhofer G. Cross Laminated Timber (CLT) in Europe – from Conception to Implementation. Presentation, University of British Columbia, Department of Wood Science, Vancouver, Canada 2010.

Schickhofer G, Bogensperger T, Moosbrugger T. BSP handbuch – Holz-Massivbauweise in Brettsperrholz, Nachweise auf Basis des neuen europäischen Normenkonzepts, 2. Auflage, Graz: Verlag der Technischen Universität Graz, 2010.

Chapter 4 – Connections

Ringhofer A, Brandner Reinhard, Blass H.J, Design approaches for dowel-type connections in CLT structures and their verification. Design of Connections in Timber Structures. A state of the art report by COS Action FP1402/WG3, 2017.

Uibel T, Blass H.J. Joints with Dowel Type Fasteners in CLT Structures. European Conference on Cross Laminated Timber (CLT). COST Action FP1004 with TU Graz, 2018.

Uibel T, Blass H.J. Load carrying capacity of joints with dowel type fasteners in solid wood panels, Paper presented at the 40th meeting of the Working Commission W18-Timber Structures, International Council for Research and Innovation in Building and Construction, Bled, Slovenia, 2007.

Wallner-Novak M, Koppelhuber J, Pock K. Cross-Laminated Timber Structural Design, Basic design and engineering principles according to Eurocode, pro:Holz, 2014.

Chapter 5 – Floors

- Blass H.J, Ehlebeck J, Kreutzinger H, Steck, G. Erläuterungen zu DIN 1052:2004-08; Entwurf, Berechnung und Bemessung von Holzbauwerken, 1. Auflage, Hrsg.: DGfH Innovations - und Service GmbH, München, 2004.
- Bogensperger T., Moosbrugger T., Silly G., Verification of CLT-plates under loads in plane. World Conference in Timber Engineering, Trento Italy, 2010.
- Hamm P, Richter A. Personeninduzierte Schwingungen bei Holzdecken – Neue Erkenntnisse führen zu neuen Bemessungsregeln, Ingenieurholzbau – Karlsruher Tage: Forschung für die Praxis, Universität Karlsruhe, 2009.
- Ohlsson S. Serviceability criteria – especially floor vibrations criteria. 1991 International timber engineering conference. TRADA vol.1 58–65, 1991.
- Ohlsson S. Svikt, svängningar och styvhet hos bjälklag – dimensioneringsmetoder, 1994.
- Östman et al. Brandsäkra trähus – Nordisk-baltisk kunskapsöversikt och vägledning, version 3, 2012.
- Wilford M, Young P. A Design Guide for Footfall Induced Vibration of Structures. (A Cement and Concrete Industry Publication), 2006.

Chapter 6 – Walls

- Abeysekera I.K, Smith A.J.R. and Lawrence A.C. Safe design of indeterminate systems in a brittle material. Properties, Testing and Design of Cross Laminated Timber. A state of the art report by COS Action FP1402/WG2, 2018.
- Associerede Ingeniörer ApS: Massivtræ i byggeriet, Træbranchens Oplysningsråd, 2001.
- Bergdahl U, Ottosson E, Stigson Malmborg B. Plattgrundläggning, SGI, Svensk Byggtjänst, 1993.
- Olsson C, Holm G. Pålgrundläggning, SIG, Svensk Byggtjänst, 1993.

Chapter 7 – CLT and fire safety

- Boverkets allmänna råd om brandbelastning, BFS 2013:11 – BBRBE 1.
- BrandEx Brandtätningar AB, Brandtätningar, <http://www.brandex.se/brandtatningar.asp> [14.02.2013], 2013.
- Brandskydd, Passivt brandskydd ofta beroende av rätt byggmaterial, <http://brandskydd.tv/2012/08/10/passivt-brandskydd-ofta-beroende-av-ratt-byggmaterial>, [08.05.2013], 2012.
- Buchanan A., Östman B., editors. Fire Safe Use of Wood in Buildings – Global Design Guide. CRC Press, 2022. Available at DOI:10.1201/9781003190318-1.
- Eriksson P-E, Nord T och Östman, B: Kartläggning av brandincidenter i flervåningshus med trästomme – Erfarenheter från 20 års brukande, SP Report 2016:12, 2016.
- Klippel M., Schmid J., Frangi A.: Fire Design of CLT, pp 101 – 122 in Proceedings of the Joint Conference of COST Actions FP1402 & 1404. Cross Laminated Timber – A competitive wood product for visionary and fire safe buildings. KTH Building Materials, Stockholm 10 March 2016.
- Östman, Mikkola, Stein, Frangi, König, Dhima, Hakkarainen, Bregulla: Fire safety in timber buildings. Technical guideline for Europe. SP Report 2010:19, Stockholm, 2010.
- Östman et al: Brandsäkra trähus – Nordisk-baltisk kunskapsöversikt och vägledning, version 3, SP Report 2012:18, Stockholm, 2012.
- Schaffer E.L.: Charring rate of selected woods – transverse to grain. US Department of Agriculture, Forest Service, Forest Products Laboratory, Research paper FPL 69, Madison, USA, 1967.
- Stein R., Werther N., Winter S.: Konstruktionskatalog für Gebäude in Holzbauweise unter Berücksichtigung bauordnungsrechtlicher und versicherungstechnischer Aspekte. Technische Universität München, 2013.
- Teibinger M., Matzinger I.: Fire-resistant sealing in timber construction. Planning brochure. Issue 38 of the HFA Schriftreihe, Holzforschung Austria, 2012.
- Willford M., Young P., CCIP-016, A Design Guide for Footfall Induced Vibration of Structures. Published by MPA The Concrete Centre.

Chapter 8 – CLT and sound

Abeysekera, I.K., Hamm, P., Toratti, T., Lawrence, A., Development of a floor vibration method for Eurocode 5. Paper 51-20-2 Proceedings International Network on Timber Engineering Research 51, Tallinn, Estonia, 2018.

Approved Document E of the Building Regulations, HM Government 2010.

British Council for Offices (BCO) guidance, 2009.

HTM 08-01, Department of Health & Social Care, 2013.

Bostäder och nya ljudkrav, Boverkets Byggekostnadsforum, 2007.

Hagberg K. Tre exempel på akustiklösningar i träbyggande. En skrift för små och medelstora byggföretag som vill bygga med lätta stomsystem, SBUF, 2013.

Larsson K, Simmons C. Vägledning för mätning av ljudnivå i rum med stöd av SS_EN ISO 1 0052/16032, SP report 2015:2, 2015.

Ljunggren F. Arbetsrapport Nr 20, Ljud- och vibrationsmätningar i testhus, Luleå University of Technology, 2016.

Ljunggren S. Ljudisolering i trähus – en handbok för konstruktörer. SP Report 2011:10, 2011

Chapter 9 – CLT and thermal comfort

CIBSE Guide A – Environmental Design, Chartered Institution of Building Services Engineers, 2015.

Construction with Cross-Laminated Timber in Multi-Storey Buildings, Guidelines, Holz Forschung Austria, 2013.

Hagentoft C-E. Introduction to Building Physics, 2001.

Holzbausysteme, Arbeitsgemeinschaft Holz e.V. Duesseldorf, 2000.

Ståhl F. Thermal properties of building materials and their influence on energy efficiency, 2009.

Werner. Brettstapelbauweise. Arbeitsgemeinschaft Holz e.V. Duesseldorf, 2000.

Chapter 10 – Procurement and site works

Esping B, Salin J-G, Brander P. Fukt i trä för byggindustrin, Fuktegenskaper, krav, hantering och mätning, SP Träteknik, 2005.

Van Riemsdijk J. Lyftredskap för KL-trä, hantering av horisontella och vertikala element i massivträ, 2014.

Degree project Chalmers University of Technology, 2014:23.

References for standards

BS EN 338:2016	Structural timber – Strength classes, BSI 2016.
BS EN 1990:2002 + A1:2005	Eurocode – Basis of structural design, BSI 2005.
BS EN 1991-1-1:2002	Eurocode 1: Actions on structures. General actions. Densities, self-weight, imposed loads for buildings, BSI 2002.
BS EN 1992-1-1:2004 + A1:2014	Eurocode 2: Design of concrete structures. General rules and rules for buildings, BSI 2014.
BS EN 1993-1-1:2005 + A1:2014	Eurocode 3: Design of steel structures. General rules and rules for buildings, BSI 2014.
BS EN 1995-1-1:2004 + A2:2014	Design of timber structures. General. Common rules and rules for buildings, BSI 2014.
BS EN 13017-1:2001	Solid wood panels. Classification by surface appearance. Solid wood panels. Softwood, BSI 2001.
BS EN 14080:2013	Timber structures. Glued laminated timber and glued solid timber. Requirements, BSI 2013.
BS EN 14081-1:2016 + A1:2019	Timber structures. Strength graded structural timber with rectangular cross section. General requirements, BSI 2019.
BS EN 15804:2012 + A2:2019	Sustainability of construction works. Environmental product declarations. Core rules for the product category of construction products, BSI 2019.
BS EN 15978:2011	Sustainability of construction works. Assessment of environmental performance of buildings. Calculation method, BSI 2011.
BS EN 16351:2021	Timber structures. Cross laminated timber. Requirements, BSI 2021.
BS EN ISO 717-1:2020	Acoustics. Rating of sound insulation in buildings and of building elements. Airborne sound insulation, BSI 2020.
BS EN ISO 717-2:2020	Acoustics. Rating of sound insulation in buildings and of building elements. Impact sound insulation, BSI 2020.
BS EN ISO 3382-2:2008	Acoustics. Measurement of room acoustic parameters. Reverberation time in ordinary rooms, BSI 2008.
BS EN ISO 6946:2017	Building components and building elements. Thermal resistance and thermal transmittance. Calculation methods, BSI 2017.
BS EN ISO 9001:2015	Quality management systems. Requirements, BSI 2015.
BS EN ISO 14001:2015	Environmental management systems – Requirements with guidance for use, BSI 2015.
BS EN ISO 14040:2006 + A1:2020	Environmental management. Life cycle assessment. Principles and framework, BSI 2020.
BS EN ISO 14044:2006 + A1:2018	Environmental management. Life cycle assessment. Requirements and guidelines, BSI 2018.
BS EN ISO 14025:2010	Environmental labels and declarations. Type III environmental declarations. Principles and procedures, BSI 2010.
BS EN ISO 16032:2004	Acoustics. Measurement of sound pressure level from service equipment in buildings. Engineering method, 2004.
BS EN ISO 16283-1:2014 + A1:2017	Acoustics. Field measurement of sound insulation in buildings and of building elements. Airborne sound insulation, BSI 2017.
BS EN ISO 16283-2:2020	Acoustics – Field measurement of sound insulation in buildings and of building elements. Impact sound insulation, BSI 2020.

Non-liability

By using the content of *The CLT Handbook*, you agree to the terms of use below.

The authors and reviewers have been responsible for interpreting building regulations, research papers, industrial documents and so on, with a view to conveying current design practices. The material presented is only intended to provide guidance; the final design responsibility lies with the structural engineer or designer.

All information is provided in its present state and without any form of guarantee, to the extent permitted by prevailing legislation. Although the publisher has taken all reasonable steps to try and provide reliable information in *The CLT Handbook*, the publisher does not guarantee that the content is free from errors, mistakes and/or omissions, or that the content is up to date and relevant to the user's needs.

The publisher, Swedish Forest Industries Federation, also provides no guarantees for any outcomes arising from use of the information contained in *The CLT Handbook*. All use of information in *The CLT Handbook* is the user's own responsibility and is done at the user's risk.

Swedish Forest Industries Federation does not accept liability for any damage or injury that may arise due to the content of *The CLT Handbook*.

Copyright

Swedish Forest Industries Federation owns the rights to the content *The CLT Handbook*. Arup owns the rights to intellectual property contributed for this UK edition, in particular Sections 3.3.2.1 (non-linear buckling method), 3.3.3 and 3.5.

The content is protected under copyright law. Misuse will be subject to a penalty. Copying of the content is prohibited.



Interior with CLT and glulam.

CLT manufacturing mills in Sweden



HOLMEN



Holmen Wood Products AB/ Martinsons Byggsystem AB

Burträskvägen 53
SE-937 80 Bygdsiljum
Sweden
Tel: +46 914 207 00
www.martinsons.se



Setra Group AB

Hagabergsvägen 3
SE-776 72 Långshyttan
Sweden
Tel: +46 225 635 00
www.setragroup.com



Stora Enso

Gruvöns sågverk
Timmervägen 2
SE-664 33 Grums
Sweden
Tel: +46 10 463 91 00
www.storaenso.com



Södra Skogsägarna ekonomisk förening

SE-432 86 Väröbacka
Sweden
Tel: +46 470 890 00
www.sodra.com

Photo credits

Introduction

Stora Enso, front cover
Martinsons, page 4
Patrik Degerman, page 7

Chapter 1

Murman Architects, page 8
Åke E:son Lindman, page 9
Angus Bremner; Malcolm Fraser Architects, page 10 (top)
Magnus Silfverhielm, page 10 (bottom)
M. Mack; dRMM Architects, page 11
Swedish Wood, pages 13 and 14
Alex de Rijke; dRMM Architects, page 15
Anders Gustafsson, pages 16, 17 and 18
Eric Borgström, page 19
Urban and Civic; dRMM Architects, page 21
Lewis Kahn; Waugh Thistleton Architects, page 22 (top)
J. Stephenson; dRMM Architects, page 22
(bottom left and right)
Joakim Kröger, page 23 (top)
Thomas Harrysson, page 23 (bottom left)
Mats Ekevad, page 23 (bottom right)

Chapter 2

Eric Borgström, page 25
Per Bergkvist, pages 26 and 30
Åke E:son Lindman, page 28
Anders Gustafsson, page 31
Peder Lindbom, pages 32 and 33

Chapter 3

D. Romero; dRMM Architects, page 35
Johan Ardefors, pages 42 and 49
Tim Crocker; Waugh Thistleton Architects, page 45

Chapter 4

Stora Enso, pages 54, 59, 60 (top) and 62
Jonas Lundqvist, page 60 (bottom)
Anders Gustafsson, page 64
Åke E:son Lindman, page 66

Chapter 5

Ed Reeve; Waugh Thistleton Architects, pages 70 and 84
Anders Gustafsson, page 71
baraBild, page 72
Stora Enso, pages 74 and 75
Patrik Degerman, page 76
Åke E:son Lindman, page 77

Chapter 6

Anders Gustafsson, page 87
Stora Enso, pages 88 and 97
Åke E:son Lindman, page 93

Chapter 7

baraBild, page 102
Anders Gustafsson, page 108

Chapter 8

Jimmy Ruljeff, page 116
Peter Jacobsson, page 119
Lendlease; dRMM Architects, page 128

Chapter 9

baraBild, page 131
Holzbau Unterrainer, page 132
Tomas Gustafsson, page 133
Will Pryce; Waugh Thistleton Architects, page 135

Chapter 10

Patrik Degerman, page 138 (top)
Jonas Lundqvist, page 138 (lower)
Kennet Gustafsson, page 139
Martinson, page 140 (left), 141
Tomas Gustafsson, page 140 (right)
Skanska, page 141 (right)

Back pages

Stora Enso, page 151

The CLT Handbook

© Swedish Forest Industries Federation, 2022
First UK edition

Publisher

Swedish Forest Industries Federation
Swedish Wood
P.O Box 55525
SE-102 04 STOCKHOLM
Sweden
Tel: +46 8762 72 60
E-mail: info@swedishwood.com
www.swedishwood.com

Project managers

Johan Fröbel – Swedish Wood
Anders Gustafsson – RISE Research Institutes of Sweden

UK Project managers

Barnaby Dickens – Swedish Wood
Tony Traynor – Swedish Wood

Editor

Johan Fröbel – Swedish Wood

Lead author

Anders Gustafsson – RISE Research Institutes of Sweden

Co-authors

Roberto Crocetti – Faculty of Engineering, Lund University
Alar Just – RISE Research Institutes of Sweden
Pierre Landel – RISE Research Institutes of Sweden
Jörgen Olsson – RISE Research Institutes of Sweden
Anna Pousette – RISE Research Institutes of Sweden
Magnus Silfverhielm – AIX Arkitekter
Birgit Östman – Linnaeus University

Reference group and fact checkers

Eric Borgström – Swedish Wood
Henrik Danielsson – Limträteknik i Falun AB/
Faculty of Engineering, Lund University
Mattias Brännström – Renewinn AB
Mats Ekevad – Luleå University of Technology
Johan Fröbel – Swedish Wood
Melker Johansson – Tyréns AB
Thomas Johansson – Moelven Töreboda AB
Rune Karlsson – Rune Karlsson Byggprojektering i Hedemora
Greger Lindgren – Holmen Wood Products AB/
Martinsons Byggsystem AB
Daniel Wilded – Holmen Wood Products AB/
Martinsons Byggsystem AB

UK edition authors

Andrew Lawrence – Arup (General)
Ishan Abeysekera – Arup (General)
Philip Wright – Arup (Chapter 8)
Sam Peckham – Arup (Chapter 8)
Jake Hacker – Arup (Chapter 9)

Language reviewer

Barnaby Dickens – Swedish Wood

Illustrations

Magnus Alkmar – Alkmar Co AB
Vendela Martinac – Thelander Arkitektur & Design AB
Cornelia Thelander – Thelander Arkitektur & Design AB

Graphic production

Formigo AB

ISBN 978-91-985212-2-1

Publications and websites from Swedish Wood

Publications

Order via www.swedishwood.com/publications.

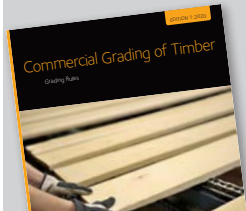

Commercial Grading of Timber

The recently updated basic manual for grading timber. 81 pages. A5 format.

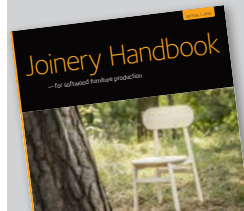

Joinery Handbook

Everything for small carpenters and students, from design to machine knowledge and surface treatments. 120 pages. A4 format.



Trä! Magazine

Quarterly magazine showcasing the best in timber architecture and interior design from Sweden and beyond.

Digital publications available in the UK

Available at www.woodcampus.co.uk.

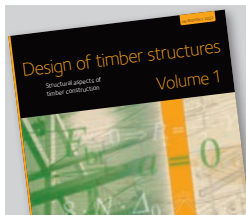

Design of timber structures, Volume 1

Structural aspects of timber construction. 256 pages. A4 format.

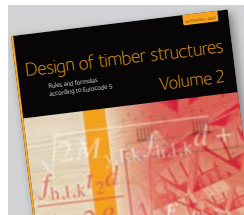

Design of timber structures, Volume 2

Rules and formulas according to Eurocode 5. 60 pages. A4 format.

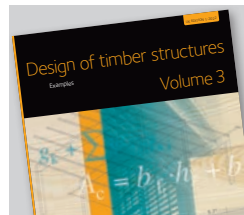

Design of timber structures, Volume 3

Examples. 60 pages. A4 format.



The CLT Handbook

CLT structures – design and detailing. 156 pages. A4 format.

Websites

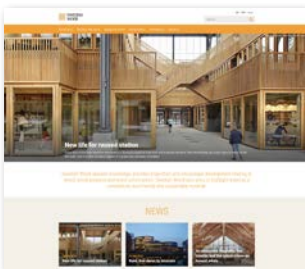

www.swedishwood.com

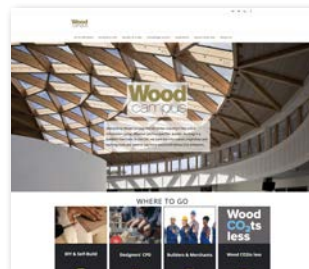

www.woodcampus.co.uk



Swedish Wood's aim is to increase the size and value of the market for Swedish wood and wood products in construction, interior design and packaging. Through inspiration, information and education, we promote wood as a competitive, renewable, versatile and natural material. Swedish Wood also lobbies on behalf of its members on key industry and trade issues.

Swedish Wood represents the Swedish sawmill industry and is part of the Swedish Forest Industries Federation. In addition, Swedish Wood represents the Swedish glulam and packaging industries, and collaborates closely with Swedish builders' merchants and wholesalers of wood products.

© Swedish Forest Industries Federation, 2022.

P.O Box 55525
SE-102 04 Stockholm
Sweden
Tel: +46 8 762 72 60
info@swedishwood.com
swedishwood.com



ISBN 978-91-985212-2-1